

User Manual

Revision 1.001
English

Modbus Slave / HART Master - Converter

(Order Code: HD67908-5-A1)

For Website information:

www.adfweb.com?Product=HD67908

For Price information:

www.adfweb.com?Price=HD67908-5-A1

Benefits and Main Features:

- ⊕ Very easy to configure
- ⊕ Triple Electrical isolation
- ⊕ Temperature range: -40°C/+85°C (-40°F/+185°F)



For other HART products see also the following link:

Converter HART Master to

www.adfweb.com?Product=HD67900
www.adfweb.com?Product=HD67901
www.adfweb.com?Product=HD67902
www.adfweb.com?Product=HD67903
www.adfweb.com?Product=HD67904
www.adfweb.com?Product=HD67905
www.adfweb.com?Product=HD67906
www.adfweb.com?Product=HD67907
www.adfweb.com?Product=HD67909
www.adfweb.com?Product=HD67910
www.adfweb.com?Product=HD67911
www.adfweb.com?Product=HD67912
www.adfweb.com?Product=HD67913

(Serial)
(BACnet Slave)
(CAN)
(CANopen)
(DeviceNet Slave)
(Ethernet)
(EtherNet/IP Slave)
(J1939)
(Modbus TCP Slave)
(MQTT)
(PROFIBUS Slave)
(PROFINET Slave)
(SNMP Agent)

Do you have your customer protocol? Then go to:

www.adfweb.com?Product=HD67003

Do you need to choose a device? Do you want help?

www.adfweb.com?Cmd=helpme



User Manual

INDEX:

| | Page |
|--|------|
| INDEX | 2 |
| UPDATED DOCUMENTATION | 2 |
| REVISION LIST | 2 |
| WARNING | 2 |
| TRADEMARKS | 2 |
| SECURITY ALERT | 3 |
| EXAMPLE OF CONNECTION | 4 |
| CONNECTION SCHEME | 5 |
| CHARACTERISTICS | 6 |
| CONFIGURATION | 6 |
| POWER SUPPLY | 7 |
| FUNCTION MODES | 8 |
| LEDS | 9 |
| HART | 10 |
| RS485 | 11 |
| ETHERNET | 12 |
| USE OF COMPOSITOR SW67908 | 13 |
| NEW CONFIGURATION / OPEN CONFIGURATION | 14 |
| SOFTWARE OPTIONS | 15 |
| SET COMMUNICATION | 17 |
| HART VARIABLES | 19 |
| UPDATE DEVICE | 21 |
| SCAN FUNCTION | 23 |
| WEBSERVER INTERFACE | 25 |
| MECHANICAL DIMENSIONS | 29 |
| ORDERING INFORMATIONS | 30 |
| ACCESSORIES | 30 |
| DISCLAIMER | 31 |
| OTHER REGULATIONS AND STANDARDS | 31 |
| WARRANTIES AND TECHNICAL SUPPORT | 32 |
| RETURN POLICY | 32 |

UPDATED DOCUMENTATION:

Dear customer, we thank you for your attention and we remind you that you need to check that the following document is:

- ✚ Updated
- ✚ Related to the product you own

To obtain the most recently updated document, note the “document code” that appears at the top right-hand corner of each page of this document.

With this “Document Code” go to web page www.adfweb.com/download/ and search for the corresponding code on the page. Click on the proper “Document Code” and download the updates.

REVISION LIST:

| Revision | Date | Author | Chapter | Description |
|----------|------------|--------|---------|--------------------------------|
| 1.000 | 18/06/2019 | Tf | All | First Release |
| 1.001 | 27/04/2020 | Ff | All | Added web pages for HART conf. |
| | | | | |

WARNING:

ADFweb.com reserves the right to change information in this manual about our product without warning.

ADFweb.com is not responsible for any error this manual may contain.

TRADEMARKS:

All trademarks mentioned in this document belong to their respective owners.

SECURITY ALERT:**GENERAL INFORMATION**

To ensure safe operation, the device must be operated according to the instructions in the manual. When using the device, legal and safety regulation are required for each individual application. The same applies also when using accessories.

INTENDED USE

Machines and systems must be designed so the faulty conditions do not lead to a dangerous situation for the operator (i.e. independent limit switches, mechanical interlocks, etc.).

QUALIFIED PERSONNEL

The device can be used only by qualified personnel, strictly in accordance with the specifications. Qualified personnel are persons who are familiar with the installation, assembly, commissioning and operation of this equipment and who have appropriate qualifications for their job.

RESIDUAL RISKS

The device is state-of-the-art and is safe. The instruments can represent a potential hazard if they are inappropriately installed and operated by untrained personnel. These instructions refer to residual risks with the following symbol:



This symbol indicates that non-observance of the safety instructions is a danger for people that could lead to serious injury or death and / or the possibility of damage.

CE CONFORMITY

The declaration is made by our company. You can send an email to support@adfweb.com or give us a call if you need it.

EXAMPLES OF CONNECTION:

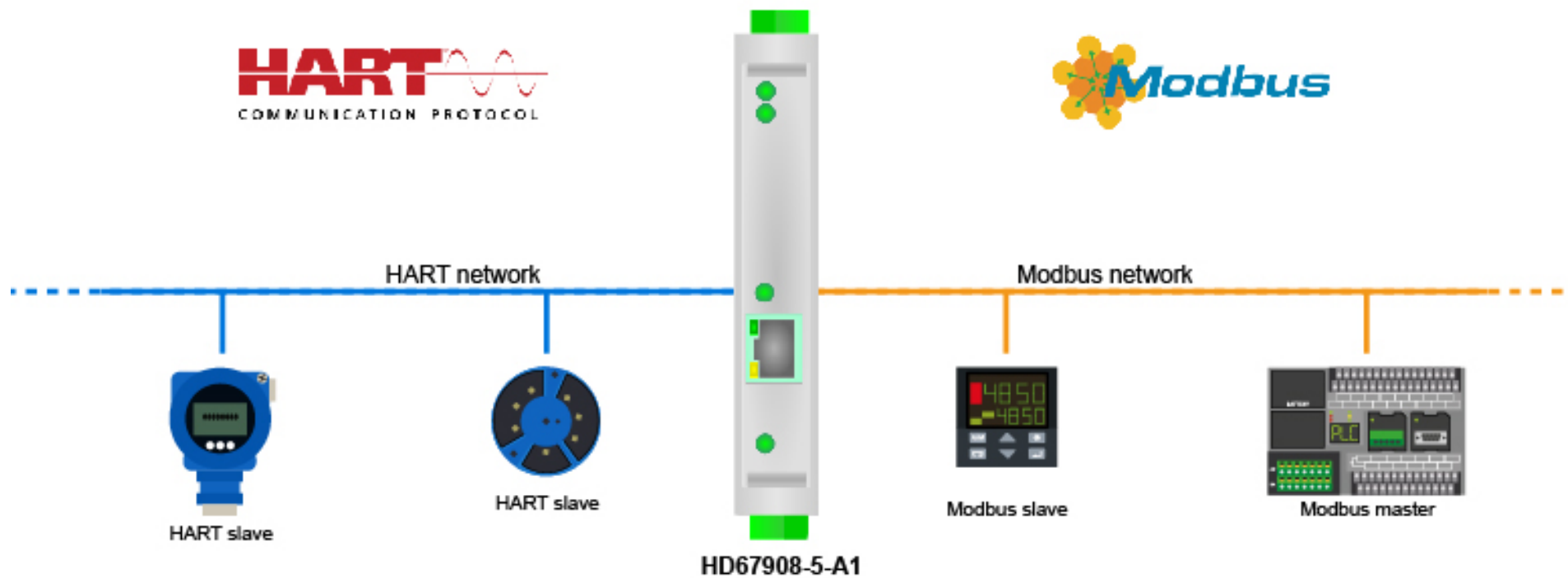

CONNECTION SCHEME:

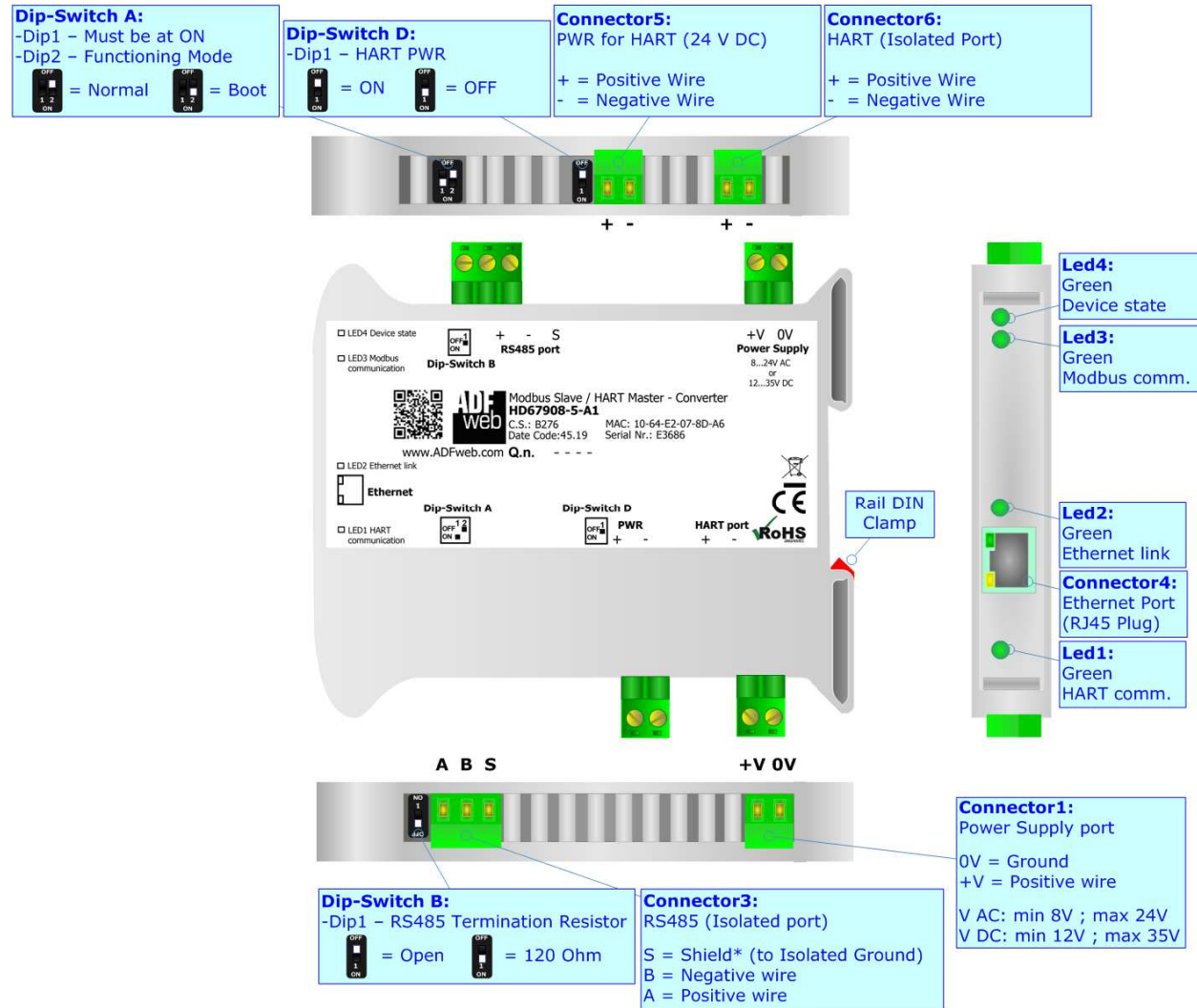

Figure 1a: Connection scheme for HD67908-5-A1

CHARACTERISTICS:

The HD67908-x-A1 are Modbus Slave / HART Master - Converters.

It allows for the following characteristics:

- Triple isolation between Serial - Power Supply, Serial - HART, HART - Power Supply;
- Two-directional information between Serial bus and HART bus;
- Mountable on 35mm Rail DIN;
- Wide power supply input range: 8...24V AC or 12...35V DC;
- Wide temperature range: -40°C / 85°C [-40°F / +185°F].



CONFIGURATION:

You need Compositor SW67908 software on your PC in order to perform the following:

- Define the parameters of Modbus line;
- Define the parameters of HART line;
- Define HART variables in read/write;
- Update the device.

POWER SUPPLY:

The devices can be powered at 8...24V AC and 12...35V DC. For more details see the two tables below.

| VAC  | | VDC  | |
|---|------|---|------|
| Vmin | Vmax | Vmin | Vmax |
| 8V | 24V | 12V | 35V |

Consumption at 24V DC:

| Device | Consumption [W/VA] |
|--------------|--------------------|
| HD67908-X-A1 | 3.5 |

Connector1:
 Power Supply port
 0V = Ground
 +V = Positive wire
 V AC: min 8V ; max 24V
 V DC: min 12V ; max 35V

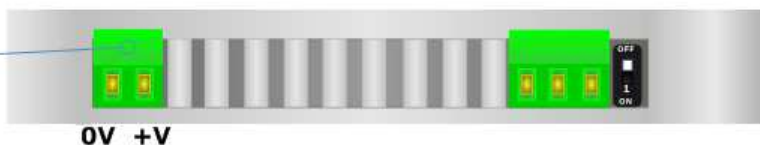

Caution: Do not reverse the polarity power

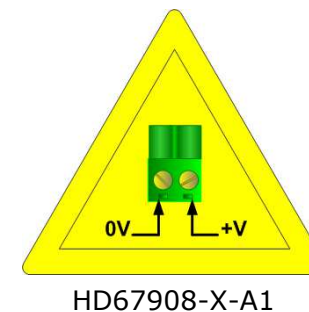

FUNCTION MODES:

The device has got two function modes depending on the position of the 'Dip2 of Dip-Switch A':

- The first, with 'Dip2 of Dip-Switch A' at "OFF" position, is used for the normal working of the device.
- The second, with 'Dip2 of Dip-Switch A' at "ON" position, is used for uploading the Project and/or Firmware.

For the operations to follow for the updating, see 'UPDATE DEVICE' section.

According to the functioning mode, the LEDs will have specific functions, see 'LEDS' section.

**Warning:**

Dip1 of 'Dip-Switch A' must be at ON position to work even if the Ethernet cable is not inserted.

LEDS:

The device has got six LEDs that are used to give information about the functioning status.
The various meanings of the LEDs are described in the table below.

| LED | Normal Mode | Boot Mode |
|---------------------------------|--|---|
| 1: HART communication (green) | It blinks when HART communication is running | Blinks quickly: Boot state Blinks very slowly (~0.5Hz): update in progress |
| 2: Ethernet link (green) | ON: Ethernet cable connected OFF: Ethernet cable disconnected | ON: Ethernet cable connected OFF: Ethernet cable disconnected |
| 3: Modbus communication (green) | It blinks when a Modbus request is received | Blinks quickly: Boot state Blinks very slowly (~0.5Hz): update in progress |
| 4: Device State (green) | Blinks slowly (~1Hz) | Blinks quickly: Boot state Blinks very slowly (~0.5Hz): update in progress |

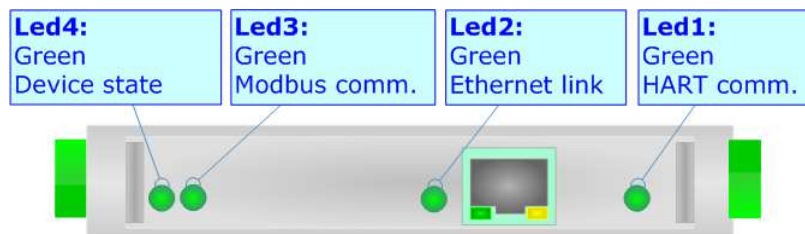

HART:

“HART” is an acronym for Highway Addressable Remote Transducer. The HART Protocol makes use of Frequency Shift Keying (FSK) standard to superimpose digital communication signals at a low level on top of the 4-20mA. This enables two-way field communication to take place and makes it possible for additional information beyond just the normal process variable to be communicated to/from a smart field instrument.

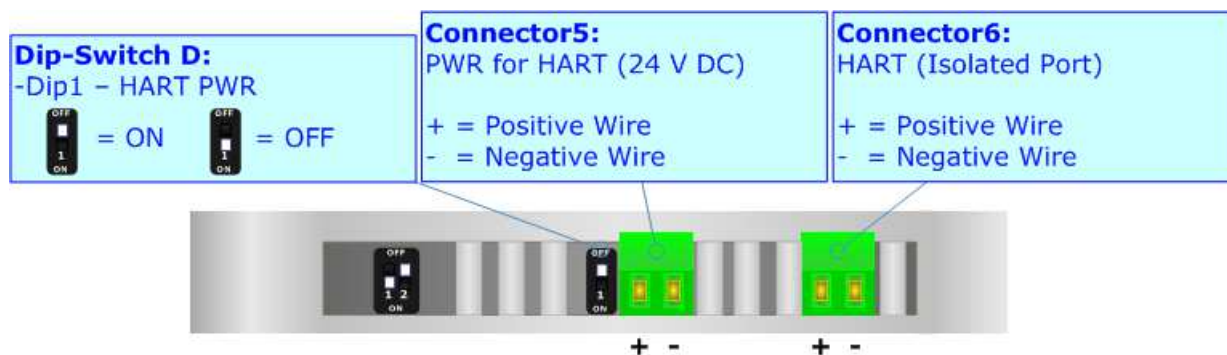

It is possible to provide the current loop for HART communication and an additional low power supply @ 24 V DC for feeding HART devices by setting Dip-Switch D at ON position. Current loop for HART is required when there is not an external device in the bus that provides it.

RS485:

For terminate the RS485 line with a 120Ω resistor it is necessary to put ON dip 1, like in figure.

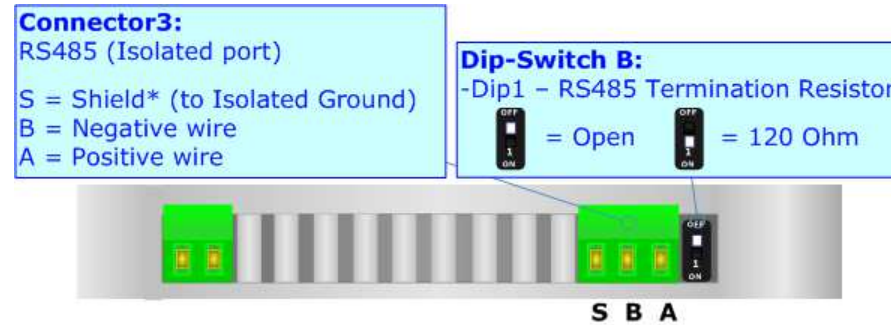

The maximum length of the cable should be 1200m (4000 feet).

Here some codes of cables:

- Belden: p/n 8132 - 2x 28AWG stranded twisted pairs conductor + foil shield + braid shield;
- Belden p/n 82842 - 2x 24AWG stranded twisted pairs conductor + foil shield + braid shield;
- Tasker: p/n C521 - 1x 24AWG twisted pair conductor + foil shield + braid shield;
- Tasker: p/n C522 - 2x 24AWG twisted pairs conductor + foil shield + braid shield.

ETHERNET:

The updating of the converters must be made using Connector4 of the HD67908-X-A1 with at least a Category 5E cable. The maximum length of the cable should not exceed 100m. The cable has to conform to the T568 norms relative to connections in cat.5 up to 100 Mbps. To connect the device to an Hub/Switch is recommended the use of a straight cable, to connect the device to a PC/PLC/other is recommended the use of a cross cable.

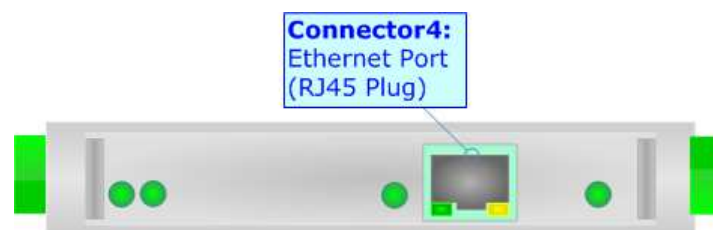

USE OF COMPOSITOR SW67908:

To configure the Converter, use the available software that runs with Windows called SW67908. It is downloadable on the site www.adfweb.com and its operation is described in this document. (*This manual is referenced to the last version of the software present on our web site*). The software works with MSWindows (XP, Vista, Seven, 8, 10; 32/64bit).

When launching the SW67908, the window below appears (Fig. 2).

**Note:**

It is necessary to have installed .Net Framework 4.



Figure 2: Main window for SW67908

NEW CONFIGURATION / OPEN CONFIGURATION:

The “**New Configuration**” button creates the folder which contains the entire device’s configuration.



A device’s configuration can also be imported or exported:

- To clone the configurations of a programmable “Modbus Slave / HART Master” in order to configure another device in the same manner, it is necessary to maintain the folder and all its contents;
- To clone a project in order to obtain a different version of the project, it is sufficient to duplicate the project folder with another name and open the new folder with the button “**Open Configuration**”.

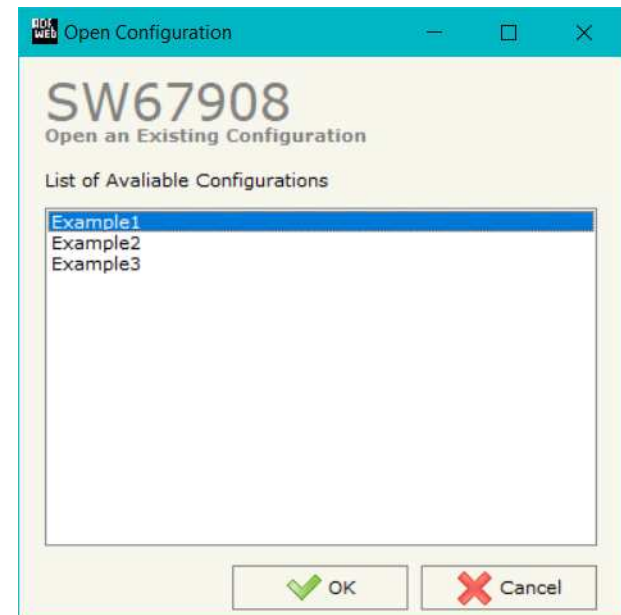

SOFTWARE OPTIONS:

By pressing the “**Settings**” () button there is the possibility to change the language of the software and check the updatings for the compositor.

In the section “Language” it is possible to change the language of the software.

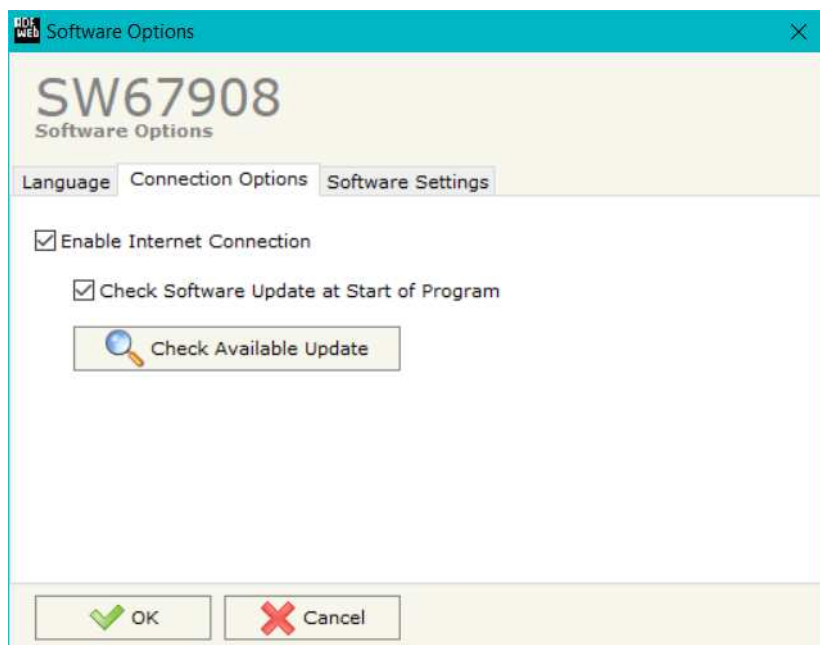

In the section “Connection Options”, it is possible to check if there are some updatings of the software compositor in ADFweb.com website. Checking the option “**Check Software Update at Start of Program**”, the SW67908 checks automatically if there are updatings when it is launched.

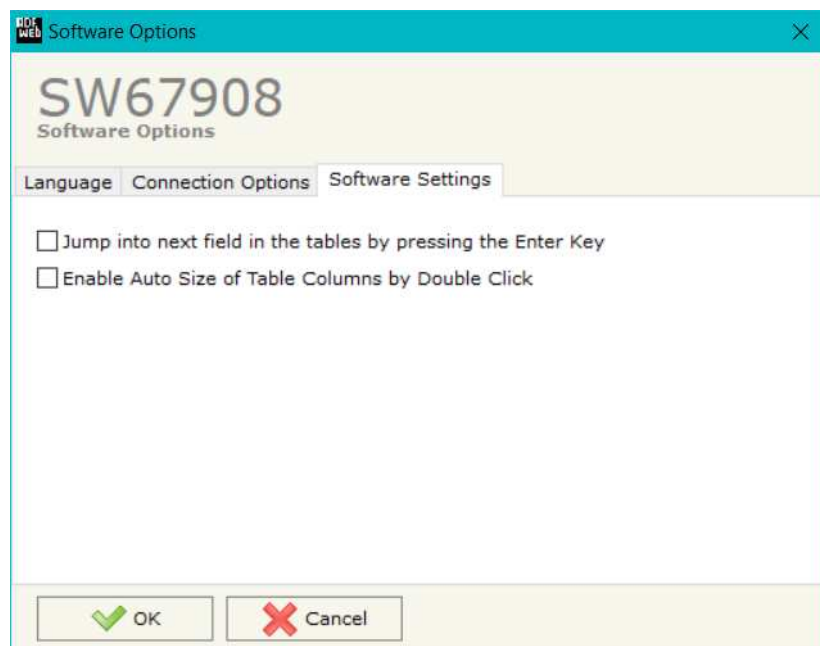

In the section "Software Settings", it is possible to enable/disable some keyboard's commands for an easier navigation inside the tables contained in the different sections of the software.

SET COMMUNICATION:

This section define the fundamental communication parameters of HART and Modbus buses.

By Pressing the **"Set Communication"** button from the main window for SW67908 (Fig. 2) the window "Set Communication" appears (Fig. 3).

The means of the fields for the "HART Master" section are:

- In the field **"Address"** the type of Master is defined;
- In the field **"Retry Limit"** the maximum number of retries in case of missing response from HART device is defined;

The means of the fields for the "Modbus Slave" section are:

- In the field **"Baudrate"** the baudrate for the serial line is defined;
- In the field **"Parity"** the parity of the serial line is defined;
- In the field **"Stop Bits"** the number of Stop Bits of the serial line is defined;
- In the field **"ID Device"** the ID of Modbus side of the converter is defined (only if "Asynchronous" mode is set);
- If the field **"Read with Input Register / Status Function"** is checked, it is possible to read the data from HART side with Input Registers (Function 04) and write the data to publish on HART side with Holding Registers (Function 06/16). The Output data are readable with Function 03. Otherwise, only Holding Registers will be used and the Output data of HART side cannot be read back.

The screenshot shows the "Set Communication" window for device SW67908. It is divided into four sections:

- HART Master:** Address is set to "Primary Master" and Retry Limit is set to "2".
- 2. Modbus Slave:** Baudrate is "115200", Parity is "NONE", Stop Bits is "1 Stop Bits", and ID Device is "10". The checkbox "Read with Input Register / Status Function" is checked.
- 3. Ethernet:** IP Address is "192.168.0.10", SubNet Mask is "255.255.255.0", and Gateway is "192.168.0.1". The "Gateway" checkbox is unchecked.
- 4. Web Pages:** Fields for "User" and "Password" are present but empty.

At the bottom, there are "OK" and "Cancel" buttons.

Figure 3: "Set Communication" window

The means of the fields for the "Ethernet" section are:

- In the field "**IP Address**" the IP address of the converter is defined;
- In the field "**SubNet Mask**" the Subnet Mask of the converter is defined;
- In the field "**Gateway**" the default gateway of the net is defined. This feature can be enabled or disabled pressing the Check Box field. This feature is used for going out of the net.

The means of the fields for the "Web Pages" section are:

- In the field "**User**" the user name for webserver's authentication is defined;
- In the field "**Password**" the password for webserver's authentication is defined.

HART VARIABLES:

By Pressing the **"HART Variables"** button from the main window for SW67908 (Fig. 2) the window "Definition of HART Variables List" appears (Fig. 4).

This section is used to define the HART variables to read/write with the Modbus Master.

| N | Enable | Device Address | Preamble Count | Type | Var/Cmd Number | Params | Position | Swap | Conv Int | Operations | Mnemonic |
|---|-------------------------------------|----------------|----------------|------|----------------|--------|----------|-------------------------------------|--------------------------|------------|--------------------------|
| 1 | <input checked="" type="checkbox"/> | 0x84EF15165C | 5 | Var | 246 | | 0 | <input checked="" type="checkbox"/> | <input type="checkbox"/> | None | Sensore di Temperatura - |
| 2 | <input checked="" type="checkbox"/> | 0x84EF15165C | 5 | Var | 247 | | 4 | <input checked="" type="checkbox"/> | <input type="checkbox"/> | None | Sensore di Temperatura - |
| 3 | <input checked="" type="checkbox"/> | 0x84EF15165C | 5 | Var | 248 | | 8 | <input checked="" type="checkbox"/> | <input type="checkbox"/> | None | Sensore di Temperatura - |
| 4 | <input checked="" type="checkbox"/> | 0x84EF15165C | 5 | Var | 249 | | 12 | <input checked="" type="checkbox"/> | <input type="checkbox"/> | None | Sensore di Temperatura - |
| 5 | <input checked="" type="checkbox"/> | 0x6DEB1AFAEA | 5 | Var | 246 | | 16 | <input checked="" type="checkbox"/> | <input type="checkbox"/> | None | ? |
| 6 | <input checked="" type="checkbox"/> | 0x6DEB1AFAEA | 5 | Var | 247 | | 20 | <input checked="" type="checkbox"/> | <input type="checkbox"/> | None | ? |
| 7 | <input checked="" type="checkbox"/> | 0x6DEB1AFAEA | 5 | Var | 248 | | 24 | <input checked="" type="checkbox"/> | <input type="checkbox"/> | None | ? |
| 8 | <input checked="" type="checkbox"/> | 0x6DEB1AFAEA | 5 | Var | 249 | | 28 | <input checked="" type="checkbox"/> | <input type="checkbox"/> | None | ? |
| 9 | <input checked="" type="checkbox"/> | | | | | | | <input type="checkbox"/> | <input type="checkbox"/> | | |

Figure 4: "HART Variables" window

The means of the fields are:

- If the field **"Enable"** is checked, the HART variable is enabled;
- In the field **"Device Address"** the address of HART device is defined;
- In the field **"Preamble Count"** the number of bytes for the synchronization is defined;
- If the field **"Type"** the type of HART parameter is defined;
- In the field **"Var/Cmd Number"** the identification of variable/command to read/write is defined. From HART standard, the most used numbers are:
 - 246: Primary Variable;
 - 247: Secondary Variable;
 - 248: Tertiary Variable;
 - 249: Quaternary Variable.

- In the field "**Params**" the parameters for the commands are defined;
- In the field "**Position**" the starting byte of the internal array where mapping the HART data is defined;
- In the field "**Swap**" the bytes' order is reversed;
- In the field "**Conv Int**" the data from HART device is converted in Integer format;
- In the field "**Operations**" a post-operation on the data read is defined;
- In the field "**Mnemonic**" a description of the variable is defined.

**Note:**

In order to configure the HART devices and their variables, it is possible to scan the HART network and get the data automatically. It is enough to click on "Scan" button. See page 22 for more info.

UPDATE DEVICE:

By pressing the **“Update Device”** button, it is possible to load the created Configuration into the device; and also the Firmware, if necessary. This by using the Ethernet port.

If you don't know the actual IP address of the device you have to use this procedure:

- Turn OFF the Device;
- Put Dip1 of 'Dip-Switch A' in ON position;
- Turn ON the device
- Connect the Ethernet cable;
- Insert the IP **“192.168.2.205”**;
- Select which operations you want to do;
- Press the **“Execute update firmware”** button to start the upload;
- When all the operations are “OK” turn OFF the Device;
- Put Dip1 of 'Dip-Switch A' in OFF position;
- Turn ON the device.

If you know the actual IP address of the device, you have to use this procedure:

- Turn ON the Device with the Ethernet cable inserted;
- Insert the actual IP of the Converter;
- Select which operations you want to do;
- Press the **“Execute update firmware”** button to start the upload;
- When all the operations are “OK” the device automatically goes at Normal Mode.

At this point the configuration/firmware on the device is correctly updated.

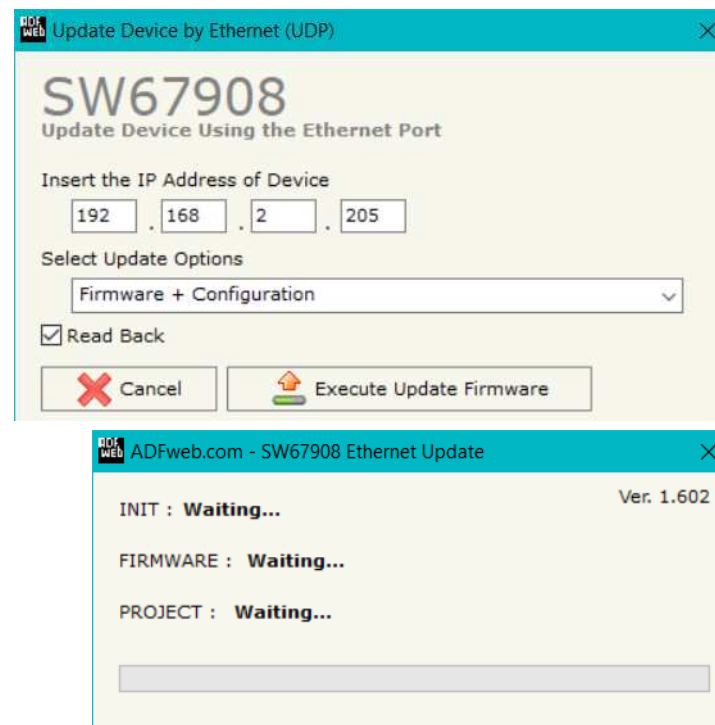

Figure 5: “Update device” windows



Note:

When you receive the device, for the first time, you also have to update the Firmware in the HD67908 device.



Warning:

If Fig. 6 appears when you try to do the Update try these points before seeking assistance:

- Try to repeat the operations for the updating;
- Try with another PC;
- Try to restart the PC;
- Check the LAN settings;
- If you are using the program inside a Virtual Machine, try to use in the main Operating System;
- If you are using Windows Seven, Vista, 8 or 10 make sure that you have the administrator privileges;
- In case you have to program more than one device, using the "UDP Update", you have to cancel the ARP table every time you connect a new device on Ethernet. For do this you have to launch the "Command Prompt" and write the command "arp -d". Pay attention that with Windows Vista, Seven, 8, 10 you have to launch the "Command Prompt" with Administrator Rights;
- Pay attention at Firewall lock.

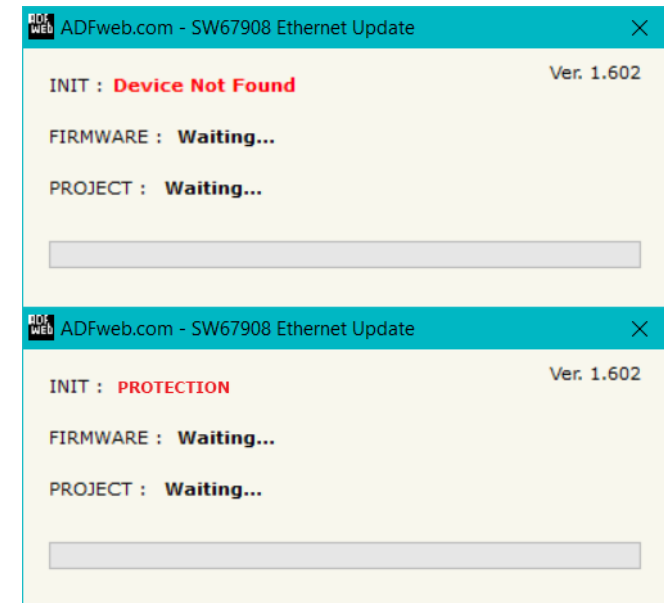

Figure 6: "Error" window



Warning:

In the case of HD67908 you have to use the software "SW67908": www.adfweb.com/download/filefold/SW67908.zip.

SCAN FUNCTION:

"SCAN" function is integrated in the configurator software SW67908. It is possible to access to these functions by simple click on the "Scan" button in "HART Variables" section.

It has the following characteristics:

- Possibility to scan HART network;
- Automatic decode of HART messages;
- Easy connection directly through the Ethernet port of the converter.

In order to start the Scan, it is necessary to use this procedure after having set the IP Address inside the converter:

- Connect the converter in Normal Mode to the PC using Ethernet port;
- Open the section "HART Variables" of SW67908;
- Click on "Scan" button. The window that appears will be like below:

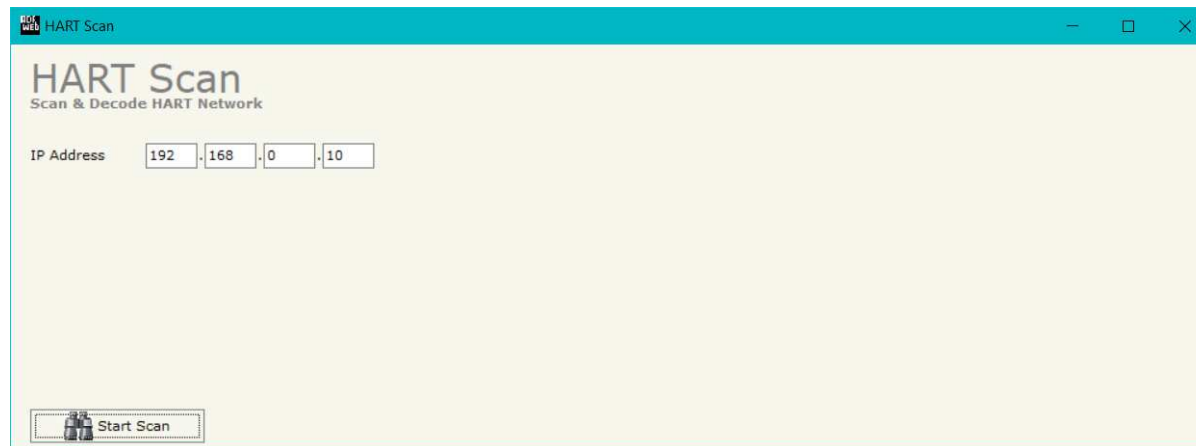

Figure 7a: "HART Scan" window

- Insert the IP Address configured in the converter;
- Start the Scan by clicking on "Start Scan" button. The window will appear like below:

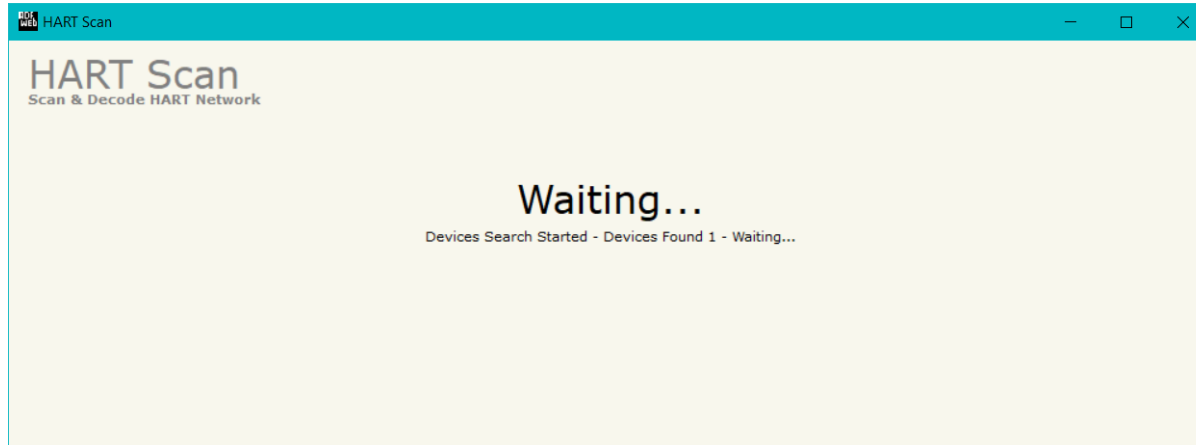

Figure 7b: "HART Scan" window

- When the Scan is complete, the software will show the results. You can import the data by clicking on "OK" button after having selected the required variables. The results will be displayed as below:

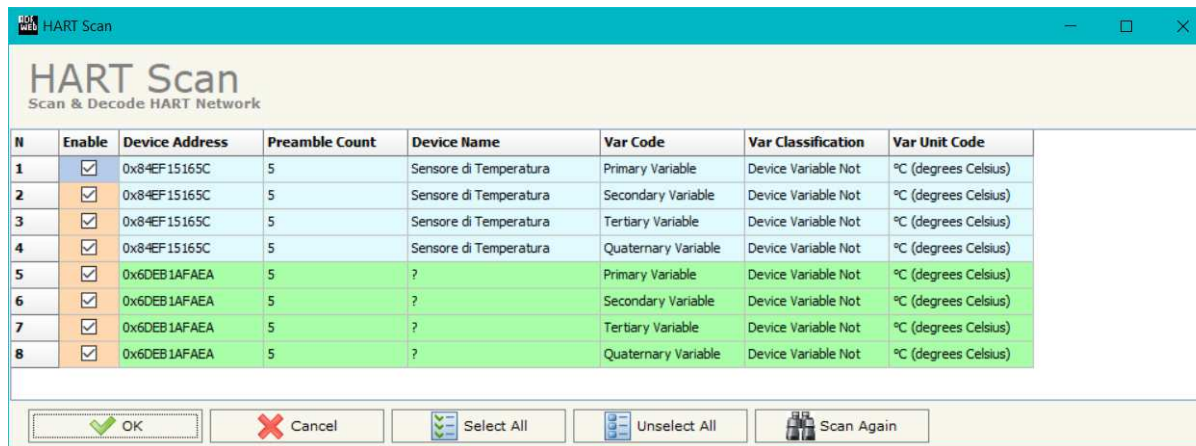

Figure 7c: "HART Scan" window

WEBSERVER INTERFACE:

The HD67908-x-A1 has an integrated Webserver that allows to scan HART network, discover HART devices and program them for first installation. It is possible to use the most common browser like Internet Explorer, Google Chrome, Mozilla Firefox by editing the IP Address of the converter in the address bar of the browser.

WELCOME



Figure 8: "Welcome" window

As soon as the connection to the Webserver interface of the Data Logger is done, "**Welcome**" window appears (Fig. 8). It has the following structure:

- "**HART Scan**" button: it is possible to go to the HART scan section where you can discover the connected HART devices;
- "**HART Control**" button: it is possible to go to the HART control section where you can program the ID and the name of the HART devices.

When one of the buttons of the “Welcome” page are pressed, it is necessary to do the login, using the “Admin” and “Password” defined in the section “Set Communication” of SW67908 (Fig. 9).

Accedi

http://192.168.2.195

La connessione a questo sito non è privata

Nome utente

Password

Figure 9: “Login” window

HART SCAN

Our converters for your connections

Hart Scan

Hart Control

Hart Scan

NUMBER OF DEVICES TO SEARCH FOR (Maximum 16)

Scan Start Read Results

FOUND 1 DEVICES

| POLLING | UNIQUE ID | DESCRIPTOR | HART VERS |
|---------|------------|--------------------------------|-----------|
| DEV 4 | 6DEB1AFAEA | PR5337D Sensore di Temperatura | HART7 |

Figure 10: "HART Scan" window

When the "HART Scan" button is pressed, the "HART Scan" window appears (Fig. 10). It has the following fields:

- "NUMBER OF DEVICES TO SEARCH FOR (Maximum 16)" field: number of Hart devices connected;
- "Scan Start" button: it is possible to start the scan of the HART network and discover the devices;
- "Read Results" button: it is possible to read the result of the last HART scan;

HART CONTROL

ADFweb Our converters for your connections

Hart Scan

Hart Control

Hart Control

UNIQUE ID

POLLING **SET NEW ADDRESS**

WRITE LONG TAG **WRITE LONG TAG**

Figure 11: "Data Logger Commands" window

When the "HART Control" button is pressed or when a discovered HART node from HART Scan section is selected, the "**HART Control**" window appears (Fig. 11). It has the following fields:

- "**UNIQUE ID**": it is possible to insert the unique ID of the HART device to control;
- "**POLLING**": it is possible to insert the new address to assign to the HART device;
- "**WRITE LONG TAG**": it is possible to defined the description of the HART device.

MECHANICAL DIMENSIONS:

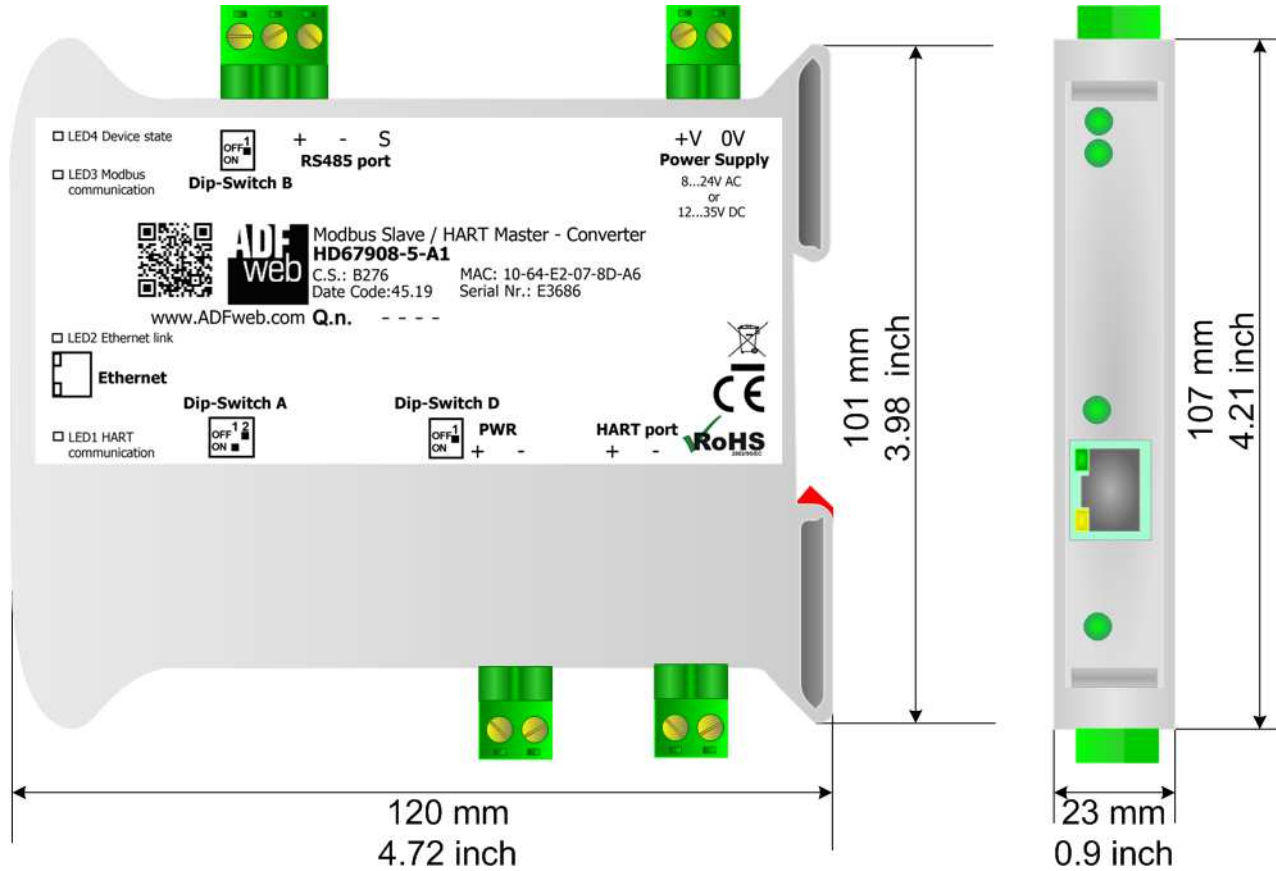

Housing: PVC
Weight: 200g (Approx)

Figure 12: Mechanical dimensions scheme for HD67908-X-A1

ORDERING INFORMATIONS:

The ordering part number is formed by a valid combination of the following:

HD67908 - x - xx

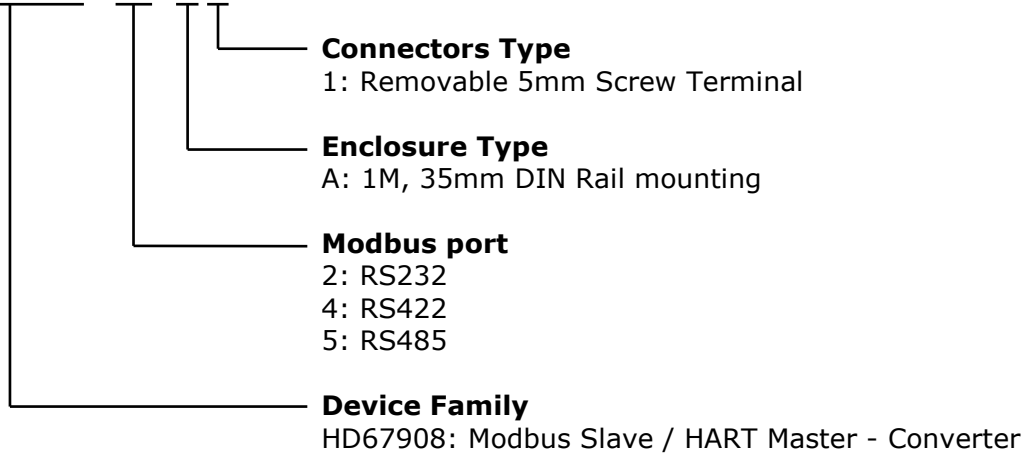

Order Code: **HD67908-5-A1** - Modbus Slave / HART Master - Converter (Modbus port: RS485)

ACCESSORIES:

Order Code: **AC34011** - 35mm Rail DIN - Power Supply 220/240V AC 50/60Hz – 12 V DC

Order Code: **AC34012** - 35mm Rail DIN - Power Supply 220/240V AC 50/60Hz – 24 V DC

DISCLAIMER:

All technical content within this document can be modified without notice. The content of the document is a under continual renewal. For losses due to fire, earthquake, third party access or other accidents, or intentional or accidental abuse, misuse, or use under abnormal conditions repairs are charged to the user. ADFweb.com S.r.l. will not be liable for accidental loss of use or inability to use this product, such as loss of business income. ADFweb.com S.r.l. shall not be liable for consequences of improper use.

OTHER REGULATIONS AND STANDARDS:**WEEE INFORMATION**

Disposal of old electrical and electronic equipment (as in the European Union and other European countries with separate collection systems).

— This symbol on the product or on its packaging indicates that this product may not be treated as household rubbish. Instead, it should be taken to an applicable collection point for the recycling of electrical and electronic equipment. If the product is disposed correctly, you will help prevent potential negative environmental factors and impact of human health, which could otherwise be caused by inappropriate disposal. The recycling of materials will help to conserve natural resources. For more information about recycling this product, please contact your local city office, your household waste disposal service or the shop where you purchased the product.

RESTRICTION OF HAZARDOUS SUBSTANCES DIRECTIVE

The device respects the 2002/95/EC Directive on the restriction of the use of certain hazardous substances in electrical and electronic equipment (commonly referred to as Restriction of Hazardous Substances Directive or RoHS).

CE MARKING

The product conforms with the essential requirements of the applicable EC directives.

WARRANTIES AND TECHNICAL SUPPORT:

For fast and easy technical support for your ADFweb.com SRL products, consult our internet support at www.adfweb.com.
Otherwise contact us at the address support@adfweb.com

RETURN POLICY:

If while using your product you have any problem and you wish to exchange or repair it, please do the following:

- Obtain a Product Return Number (PRN) from our internet support at www.adfweb.com. Together with the request, you need to provide detailed information about the problem.
- Send the product to the address provided with the PRN, having prepaid the shipping costs (shipment costs billed to us will not be accepted).

If the product is within the warranty of twelve months, it will be repaired or exchanged and returned within three weeks. If the product is no longer under warranty, you will receive a repair estimate.



ADFweb.com S.r.l.
Via Strada Nuova, 17
IT-31010 Mareno di Piave
TREVISO (Italy)
Phone +39.0438.30.91.31
Fax +39.0438.49.20.99
www.adfweb.com

