



SW550X Industrial Wireless Serial Device Server Series User's Manual



v. 1.1
October, 2012

Important Announcement

The information contained in this document is the sole property of Atop Technologies, Inc. and is supplied for the sole purpose of operation and maintenance of Atop Technologies, Inc products. No part of this publication is to be used for any other purposes, and is not to be reproduced, copied, disclosed, transmitted, stored in a retrieval system, or translated into any human or computer language, in any form, by any means, in whole or in part, without the prior explicit written consent of Atop Technologies, Inc., offenders will be held liable for damages. All rights, including rights created by patent grant or registration of a utility model or design, are reserved.

Disclaimer

We have checked the contents of this manual for agreement with the hardware and software described. Since deviations cannot be precluded entirely, we cannot guarantee full agreement. However, the data in this manual is reviewed regularly and any necessary corrections included in subsequent editions. Suggestions for improvement are welcomed. All other product names referenced herein are registered trademarks of their respective companies.

Published and Printed by

Atop Technologies, Inc.
2F, No. 146, Sec. 1, Tung-Hsing Rd.
Jubei, Hsinchu 30261
Taiwan, R.O.C.
Tel: 886-3-5508137
Fax: 886-3-5508131
www.atop-tech.com
www.atop.com.tw

Copyright © 2011 Atop Technologies, Inc. All rights reserved. Technical data is subject to change.

Contents

Preface	1
1 Introduction	4
1.1 Product Overview	4
1.2 Features	5
2 Getting Started	6
2.1 Inside the Package	6
2.2 Front & Power Panels	7
2.3 First Time Installation	10
2.4 User Interface Overview	11
2.5 Factory Default Settings	13
3 Configuration	16
3.1 Administrator Login	16
3.2 Operation Mode	18
3.3 Overview	19
3.3.1 Wireless Status	20
3.3.2 Site Monitor	21
3.4 Network Settings	23
3.5 Wireless	25
3.5.1 Basic Settings	25
3.5.2 Advanced Settings	30
3.6 Serial	32
3.6.1 COM Configuration	32
3.6.2 COM Configuration	33
3.6.3 COM Configuration: Advanced Settings	34
3.7 SNMP/ALERT Settings	37
3.8 E-mail Settings	39

3.9	Log Settings	40
3.9.1	System Log Settings	40
3.9.2	COM Log Settings	41
3.9.3	Event Log	42
3.9.4	COM Datalog	43
3.10	System Setup	44
3.10.1	Date/Time Settings	44
3.10.2	Admin Settings	45
3.10.3	Firmware Upgrade	46
3.10.4	Backup/Restore Setting	47
3.10.5	Management List	48
3.10.6	Ping	49
3.11	Reboot and Restore Default Settings	50
4	Link Modes and Applications	51
4.1	Link Mode Configuration	51
4.1.1	Link Mode: Configure SW550X as a TCP Server	52
4.1.2	Link Mode: Configure SW550X as a TCP Client	57
4.1.3	Link Mode: Configure SW550X in UDP	61
4.2	Link Mode Applications	65
4.2.1	TCP Server Application: Enable Virtual COM	65
4.2.2	TCP Server Application: Enable RFC 2217	66
4.2.3	TCP Client Application: Enable Virtual COM	66
4.2.4	TCP Client Application: Enable RFC 2217	67
4.2.5	TCP Server Application: Configure SW550X as a Pair Connection Master	67
4.2.6	TCP Client Application: Configure SW550X as a Pair Connection Slave	69
4.2.7	TCP Server Application: Enable Reverse Telnet	70
4.2.8	UDP Application: Multi-Point Pair Connection	71
4.2.9	TCP Server Application: Multiple TCP Connections	73

4.2.10	TCP Server Application: Multi-Point TCP Pair Connections	74
4.3	Wireless Topology	75
4.3.1	Configure SW550X as a Wireless Ad-Hoc Peer	75
4.3.2	Configure SW550X as a Wireless Client in the Infrastructure mode (PSK)	77
4.3.3	Click -2-Go	78
4.3.4	Configure SW550X as a Wireless Client in the Infrastructure mode (PEAP-MSCHAPv2)	79
5	VCOM Installation & Troubleshooting	81
5.1	Enabling VCOM	81
5.1.1	VCOM driver setup	84
5.1.2	Limitation	84
5.1.3	Installation	85
5.1.4	Uninstalling	85
5.2	Enable VCOM Serial device servers and select VCOM in Windows	86
5.2.1	Enable VCOM in Serial device servers	86
5.2.2	Running Serial/IP in Windows	87
5.2.3	Configuring VCOM Ports	90
5.3	Exceptions	93
5.4	Using Serial/IP Port Monitor	99
5.4.1	Opening the Port Monitor	99
5.4.2	The Activity Panel	99
5.4.3	The Trace Panel	101
5.5	Serial/IP Advanced Settings	102
5.5.1	Using Serial/IP with a Proxy Server	104
6	Specifications	105
6.1	Hardware	105
6.2	Software Specifications	115

Emergency System Recovery..... 116

Warranty 118

Preface

Purpose of the Manual

This manual supports you during the installation and configuring of the SW550X Series only, as well as it explains some technical options available with the mentioned product. As such, it contains some advanced network management knowledge, instructions, examples, guidelines and general theories designed to help users manage this device and its corresponding software; a background in general theory is a must when reading it. Please refer to the Glossary for technical terms and abbreviations.

Who Should Use This User Manual

This manual is to be used by qualified network personnel or support technicians who are familiar with network operations; it might be useful for system programmers or network planners as well. This manual also provides helpful and handy information for first time users. For any related problems please contact your local distributor, should they be unable to assist you, please redirect your inquiries to www.atop.com.tw or www.atop-tech.com .

Supported Platform

This manual is designed for the SW550X Series and that model only.

Warranty Period

We provide a **5 year limited warranty** for SW550X Series.

Manufacturers Federal Communication Commission Declaration of Conformity Statement

Model: SW550X Series

NOTE: This equipment has been tested and found to comply with the limits for a Class A digital device, pursuant to Part 15 of the FCC Rules. These limits are designed to provide reasonable protection against harmful interference when the equipment is operated in a commercial environment. This equipment generates, uses, and can radiate radio frequency energy and, if not installed and used in accordance with the instruction manual, may cause harmful interference to radio communications. Operation of this equipment in a residential area is likely to cause harmful interference in which case the user will be required to correct the interference at his expense.

This device complies with Part 15 of the FCC Rules. Operation is subject to the following

two conditions:

- 1 This device may not cause harmful interference, and
- 2 This device must accept any interference received, including interference that may cause undesired operation.

This device and its antenna(s) must not be co-located or operating in conjunction with any other antenna or transmitter.

FCC Caution: Any changes or modifications not expressly approved by the party responsible for compliance could void the user's authority to operate this equipment.

For product available in the USA/Canada market, only channel 1~11 can be operated. Selection of other channels is not possible.

This device is restricted to indoor use when operated in the 5.15 to 5.25 GHz frequency range
※ use. FCC requires this product to be used indoors for the frequency range 5.15 to 5.25 GHz to reduce the potential for harmful interference to co-channel Mobile Satellite systems.

FCC Radiation Exposure Statement:

This equipment complies with FCC radiation exposure limits set forth for an uncontrolled environment. This equipment should be installed and operated with minimum distance 20cm between the radiator & your body.

European Community, Switzerland, Norway, Iceland, and Liechtenstein

Model: SW550X Series

Declaration of Conformity with regard to the R&TTE Directive 1999/5/EC

This equipment is in compliance with the essential requirements and other relevant provisions of 1999/5/EC.

The following standards were applied:

EMC—EN 301.489-1 v1.4.1; EN 301.489-17 v1.2.1

Health & Safety—EN60950-1: 2001; EN 50385: 2002

Radio—EN 300 328 v 1.7.1; EN 301.893 v 1.5.1

The conformity assessment procedure referred to in Article 10.4 and Annex III of Directive 1999/5/EC has been followed.

This device also conforms to the EMC requirements of the Medical Devices Directive 93/42/EEC.

Note This equipment is intended to be used in all EU and EFTA countries. Outdoor use may be restricted to certain frequencies and/or may require a license for operation. For more details, contact Cisco Corporate Compliance.

European Union

This system has been evaluated for RF exposure for Humans in reference to the ICNIRP (International Commission on Non-Ionizing Radiation Protection) limits. The evaluation was based on the EN 50385 Product Standard to Demonstrate Compliance of Radio Base stations and Fixed Terminals for Wireless Telecommunications Systems with basic restrictions or reference levels related to Human Exposure to Radio Frequency Electromagnetic Fields from 300 MHz to 40 GHz. The minimum separation distance from the antenna to general bystander is 20cm (7.9 inches).

UL Notice for Power supplier

The SW550X Series products are intended to be supplied by a Listed Power Unit marked with “LPS” (Limited Power Source), or “Class 2” and output rate of 9~48 VDC, 1.0 A minimum, or use the recommended power supply listed in “Optional Accessories”.

1 Introduction

1.1 Product Overview

The SW550X Industrial Wireless Serial Device Server is the newest in our wireless series designed to provide connectivity to clients and serial devices creating a complete solution for your wireless networking.

As an example, you can connect serial devices to our Wireless Serial Server and connect these two to a **Wireless** device; this example illustrates how to connect serial devices to a local area network or a backbone network, Fig. 1. 1. The **SW550X** series provide several functionalities to support mobile and wireless networking.

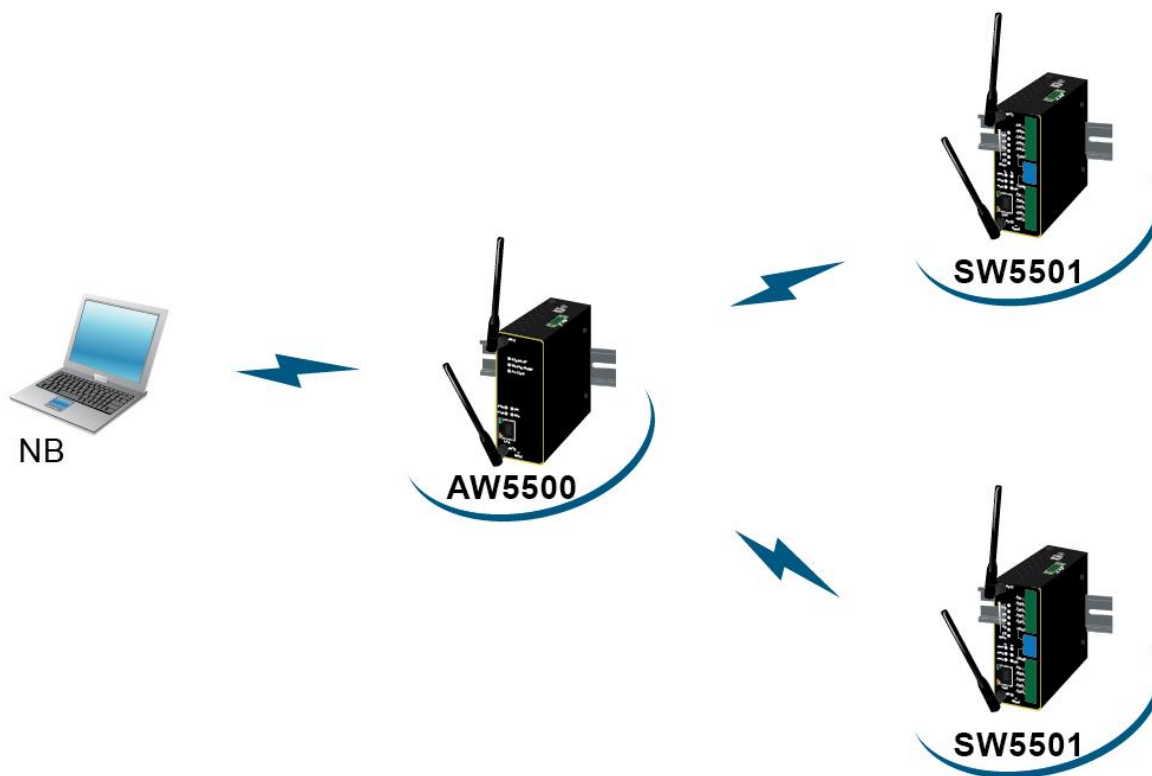

Fig. 1. 1

1.2 Features

The SW550X Series is our latest addition to our Industrial Wireless products; its small size but powerful architecture makes it a perfect choice for industrial/manufacturing needs in which size is a decisive factor. It rewards our customers with superb connectivity withstanding all the harshness in your environment of choice. Among its many characteristics, we could mention:

- 5 GHz frequency support to reduce interference on 2.4 GHz with other wireless devices.
- Dual antenna design that offers better wireless coverage and reduces wireless blind spots.

Caution

Beginning from here there will be extreme caution exercised.



Never install or work on electrical or cabling during periods of lightning activity. Never connect or disconnect power when hazardous gases are present.



WARNING: Disconnect the power and allow to cool 5 minutes before touching.

2 Getting Started

2.1 Inside the Package

Inside the product purchased you will find the following items:

Table 2. 1

Item	Quantity	Description
SW550X	1	Industrial Wireless Serial Device Server
Antenna	2	3~5 dBi antenna
TB3	1	3-pin 5.08mm lockable Terminal Block
TB5	1	5-pin 5.08mm lockable Terminal Block (SW5501-TB/SW5501-Sis only)
TB5	2	5-pin 5.08mm lockable Terminal Block (SW5502-TB/SW5502-Sis only)
Installation Guide + Warranty Card	1	
Din Rail Kit	1	Already mounted to the device
CD (Utilities)	1	Inside you will find: <ul style="list-style-type: none">● User's Manual● Installation Guide● Serial Manager© Utility

Note: Please notify your sales representative if any of the above items is missing or damaged in any form upon delivery. If your sales representative is unable to satisfy your enquiries, please contact us directly.

2.2 Front & Power Panels

The **Front**, and **Power** panels, are as follow:



Fig. 2. 1

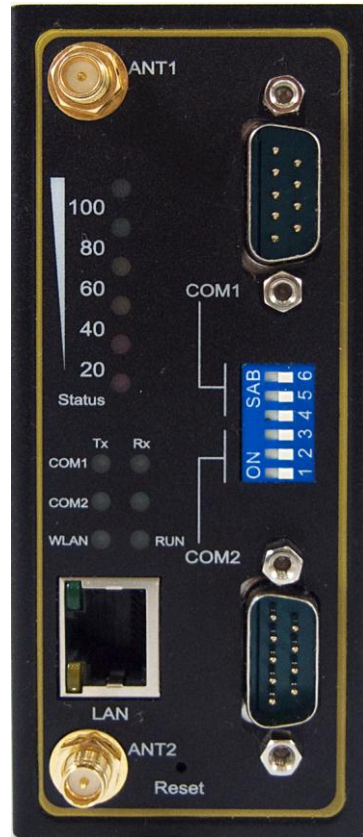

Fig. 2. 2



Fig. 2. 3



Fig. 2. 4

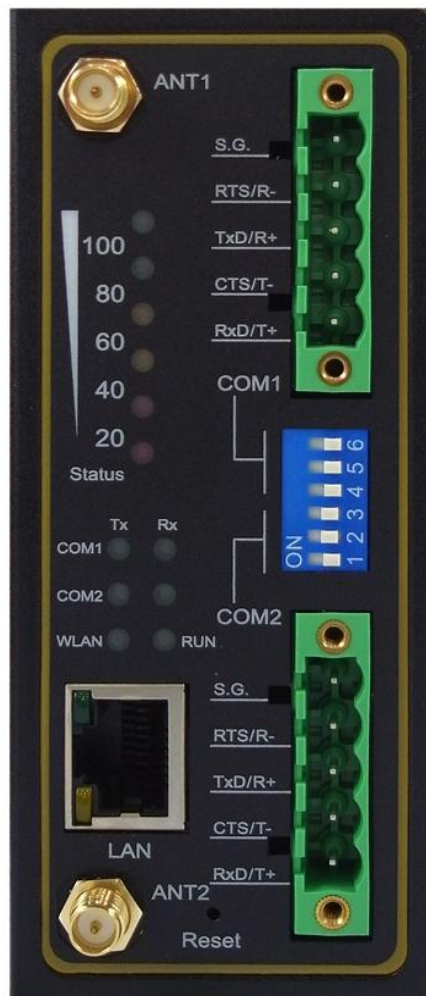

Fig. 2. 5

Note: the following front panel figures correspond to the following models.

Model	Figure
SW5501	Fig. 2. 1
SW5502	Fig. 2. 2
SW5501-TB / SW5501-Sis	Fig. 2. 4
SW5502-B / SW5502-Sis	Fig. 2. 5

The **Rear panel** (where you can mount the device on a rail or to the wall), looks as in Fig. 2. 6, a simple mounting instruction is given on Fig. 2. 7.



Fig. 2. 6

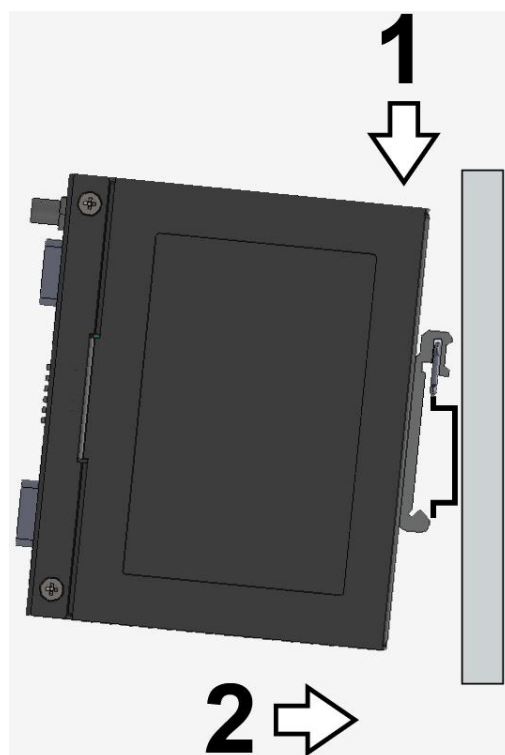

Fig. 2. 7

2.3 First Time Installation

Before installing the device, please adhere to all safety procedures described below, Atop will not be held liable for any damages to property or personal injuries resulting from the installation or overall use of the device. **Do not attempt to manipulate the product in any way if unsure of the steps described here², in such cases please contact your dealer immediately.**

- 1 Prepare the necessary cables, DC adapter, power cord, LAN cable, serial cable, etc.; **do not connect the unit yet.**
- 2 Install both antennas to the SMA connectors.
- 3 Proceed then to plug the power source to the unit, starting from the ground and then the terminal block.
- 4 Place the device in the desired location and connect it to the **LAN** via an **Ethernet cable** with an **RJ45 connector**.
- 5 Connect your computer to the **LAN** network. Default configurations will be addressed later on [Sec. 2.5](#).

Note²: remember to please consult your Hardware Installation Guide when attempting an installation. Also, please follow all safe procedures when doing so.

2.4 User Interface Overview

The SW550X Series is designed as a Wireless Client with the ability to choose between two different WLAN and LAN networks, its user interface is designed intuitively for ease of use to suit the customer needs. The web configuration appears as follows, Fig. 2. 8.

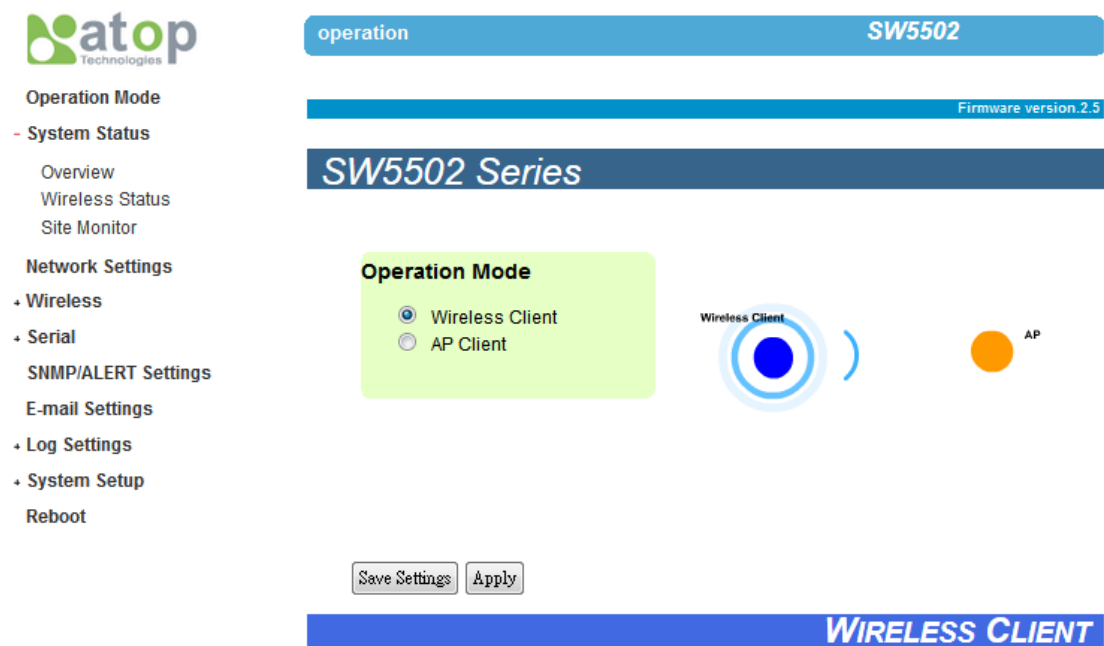

Fig. 2. 8



On the left side, a menu-tree appears with all the modes and options available (Fig. 2. 9), while on the right side of your screen the contents of each mode/option will be displayed in a graphical state. For more information on each selection please refer to each option's Section throughout the manual.

- Operation Mode**
- **System Status**
 - Overview
 - Wireless Status
 - Site Monitor
- Network Settings**
- **Wireless**
 - Basic Settings
 - Advanced Settings
- **Serial**
 - COM1
 - COM2
- SNMP/ALERT Settings**
- E-mail Settings**
- **Log Settings**
 - System Log Settings
 - COM Log Settings
 - Event Log
 - COM Datalog
- **System Setup**
 - Date/Time Settings
 - Admin Settings
 - Firmware Upgrade
 - Backup/Restore Setting
 - Management List
 - Ping
- Reboot**

Fig. 2. 9

It is also worth noting that as a first step to view your device's overall settings, you should use **Serial Manager**® (the utility provided in the CD). There will be however, three buttons which will be present during almost each section, Table 2. 2.

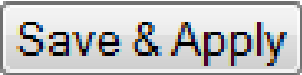
Table 2. 2

Button	Function
	Saves and apply the current configuration input on the page.
	As the caption implies, it applies the current configuration until the device is restarted.
	Cancel the current configuration input and shows the original setting.

2.5 Factory Default Settings

Upon arrival, the device will be set as follows, note that the SW550X Series comes with two different IP address for LAN and WLAN, Table 2. 3.

Table 2. 3

Interface	Device IP	Subnet mask	Gateway IP	DNS1
LAN	10.0.50.100	255.255.0.0	10.0.0.254	168.95.1.1
WLAN	192.168.1.1	255.255.255.0	192.168.1.254	

Once the device is connected to the network, you can use your browser to configure the device. An authentication request will appear as in Fig. 2. 10.

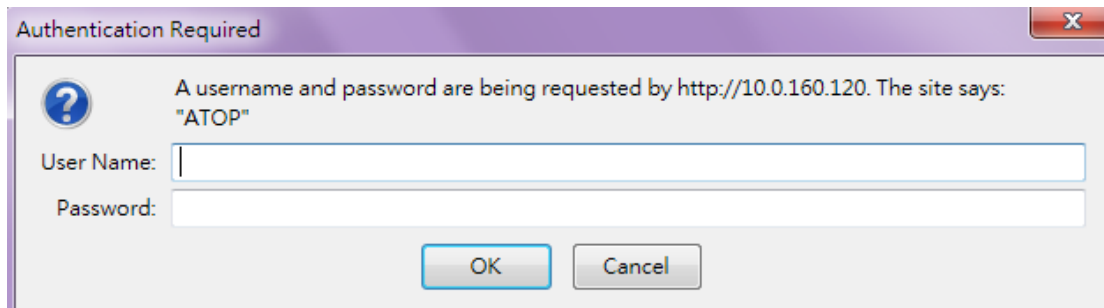

Fig. 2. 10

Other relevant default settings are as in Table 2. 4.

Table 2. 4

Parameter	Default Values
Security	
User Name	admin
Password	Null (<i>blank</i>)
Serial	
● COM1	RS-232 (RS-422 for Sis models), 9600 bps, 8 data bits, None Parity bit, 1 stop bit, None Flow Control
● COM2	Packet Delimiter timer: Auto
SNMP	
SysName of SNMP	0060E9XXXXXX
SysLocation of SNMP	location
SysContact of SNMP	contact
SNMP	Disabled
Read Community	public
Write Community	private
SNMP Trap Server	0.0.0.0

3 Configuration

3.1 Administrator Login

As soon as the device is connected on the web, the user can proceed to navigate through its configuration using **Serial Manager**®, (utility that comes in the CD); as noted in Fig. 3. 1 below, important information such as the IP, MAC address, etc is going to be displayed.

The screenshot shows the Serial Manager V4.8.0 application window. The main area contains a table with the following columns: No., Caution, Model, IP Address, MAC Address, Host Name, Kernel, and AP Information. The table lists various device models and their associated IP and MAC addresses. Row 62 is highlighted in blue, showing a device with IP 10.0.10.20 and MAC 7F68BF-D3B610.

No.	Caution	Model	IP Address	MAC Address	Host Name	Kernel	AP Information
31		GW26A-104	10.0.51.26			V2.22	ATOP Proxi.A SOYAL V2.99 T 4660
32		GW27A	10.0.210.3			V2.18	207DVS27A TCP[M=NB,SM=TCP,224.0.0.1 ,1000,PQ07,I
33		GW51C-MAXI-WD	10.0.51.69		C-MAXI	V2.45	TerminalSrv v3.30X S
34	!	SC5404D	10.0.50.100			V5.3	Serial Server V5.3
35		SC5404D	10.0.176.111			V5.2	Serial Server V5.2
36		SE1302	10.0.179.110			V1.15	SDK V1.16
37		SE1302-50	10.0.51.251			V1.15	SDK V1.16
38		SE5001A	10.0.190.106		name	V2.62	TerminalSrv v3.460U SS
39		SE5016	10.0.172.161			V4.10	Serial Server V4.12
40	! ?	SE5116	10.0.50.100			V2.0	SDK V2.0
41	?	SE5116	10.0.55.16			V2.0	SDK V2.0
42		SE5116	10.0.190.112			V1.18	SDK V1.22
43		SE5116	192.168.1.112			V1.18	SDK V1.22
44		SE5302-10	10.0.5.10		yyyyyyyyyyyyyyyy	V1.1	SE5302-10 Ver 2.0.7
45		SE5302-10	192.168.1.1		yyyyyyyyyyyyyyyy	V1.1	SE5302-10 Ver 2.0.7
46		SE5404	10.0.50.102			V3.11	Serial Server V3.17
47		SE5404	10.0.189.46			V3.26	Serial Server V3.42
48		SE5404-S5is	10.0.154.99			V3.22	Serial Server V3.32
49		SE5404D	10.0.173.100			V1.12	Modbus Gateway V2.16
50		SE5516	10.0.154.90			V2.16	SE5516 V2.18
51		SE9001-T-14M	10.0.21.100			V2.31	Manufactory Mode
52	?	SE9001-T-14M	10.0.51.106		Optoma Projector	V2.31	ProWebSrv ver Optoma_PJ_S0.26
53	@ ?	SE9001-T-14M	10.0.195.226		Optoma Projector	V2.31	ProWebSrv ver Optoma_PJ_S0.18
54		SE9001-T-31F	10.0.167.177		SONY-FWD	V2.31	ProWebSrv ver1.045Aor
55		STE-501C	10.0.49.33		name	V2.62	TerminalSrv v3.520-37 S
56	! ?	STW-611C	10.0.172.119			V1.30	STW-611C V4.50
57	!	STW-612C	10.0.50.100		7CCB0D-060000	V1.30	STW-612C V4.50
58	! ?	STW-612C	10.0.172.119			V1.30	STW-612C V4.50
59	!	SW5001	10.0.50.100			V1.30	SW5001-WgN1 V4.50
60	!	SW5502	0.0.0.0		7F68BF-D3B610	V1.13	SW5502 V1.13
61	!	SW5502	0.0.0.0		48088A-3C4808	V1.16	SW5502 V1.16
62	+	SW5502	10.0.10.20		7F68BF-D3B610	V1.13	SW5502 V1.13
63		SW5502	10.0.189.58		48088A-3C4808	V1.16	SW5502 V1.16
64		Unknown	10.0.192.102			V1.15	Data Terminal v1.02, 4660, IP=0.0.0.0, 0 listening, sec=639

Fig. 3. 1

If the name of your device is selected and then double-clicked, a window will pop-out that will prompt you to enter username and password (see [Factory Default Settings](#) for more information), proceed then to click **“Login”**, Fig. 3. 2.

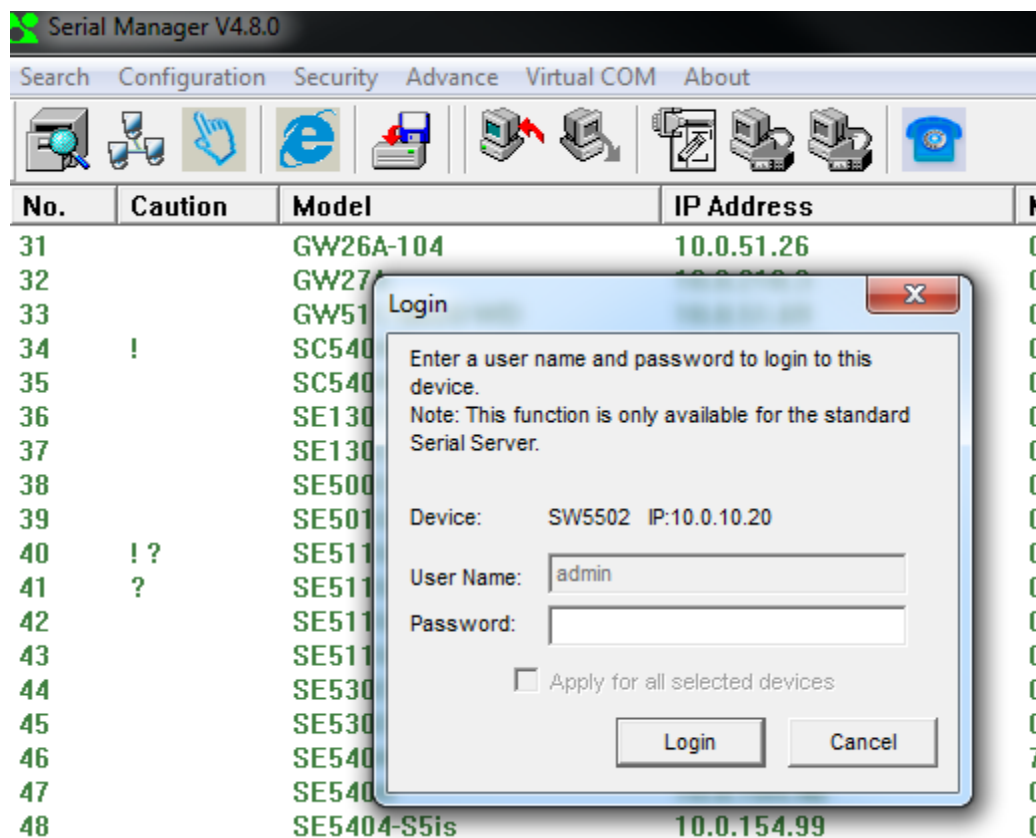

Fig. 3. 2

The device can then be accessed through the utility's interface; another way of doing this is by selecting the device and then choosing the "Config by browser" option.

3.2 Operation Mode

This is the welcome screen for the SW550X Series. There are two operation modes to choose from: **Wireless Client** and **AP Client**. In **Wireless Client** mode, SW550X will have **two independent** network interfaces, LAN and WLAN. Each interface would have its own IP address; hence traffics from the LAN interface would not be bypassed to the WLAN interface, and vice versa. In the **AP Client** mode, the LAN and WLAN interfaces would **bridge together** to create one single Bridge interface using one IP address. Traffic from either side of the network would be passed onto the other side of the network.

The screenshot displays the configuration interface for the SW5502 Series. On the left is a navigation menu with the Atop Technologies logo at the top. The menu items are: Operation Mode, System Status (with sub-items Overview, Wireless Status, Site Monitor), Network Settings, Wireless, Serial, SNMP/ALERT Settings, E-mail Settings, Log Settings, System Setup, and Reboot. The main content area features a blue header bar with 'operation' and 'SW5502'. Below this is a bar for 'Firmware version 2.5' and a dark blue bar with 'SW5502 Series'. The 'Operation Mode' section has a light green background and contains two radio buttons: 'Wireless Client' (selected) and 'AP Client'. To the right is a diagram showing a 'Wireless Client' icon (a blue circle with concentric circles) and an 'AP' icon (an orange circle). At the bottom of the main area are 'Save Settings' and 'Apply' buttons, and a blue bar at the very bottom with 'WIRELESS CLIENT' in white text.

3.3 Overview

Here you will find overall as well as general information.

System Status > Overview
SW5502

Overview

The general device information of ATOP-Serial Server.

<i>Device Information</i>	
Model Name	SW5502
Device Name	0060E90B4EB0
Kernel Version	2.5
AP Version	2.5

<i>Network Information</i>		
LAN	MAC Address	00:60:e9:0b:4e:b0
	IP Address	10.0.160.120
WLAN	MAC Address	00:60:e9:0b:4e:b1
	Country code	US
	IP Address	192.168.1.1
	Status	Disconnected

<i>COM 1 Information</i>	
Serial Interface	RS-232
Link Mode	TCP Server
Baud Rate	9600
Parity	None
Data bits	8
Stop bits	1
Flow Control	None
Link Status	SERVER MODE: Listening[0]

<i>COM 2 Information</i>	
Serial Interface	RS-232
Link Mode	TCP Server
Baud Rate	9600

Fig. 3. 3

3.3.1 Wireless Status

Wireless Network values will be displayed in this section, the default and current information can be compared side by side. Please remember to always keep a copy of your own preferred settings.

System Status > Wireless Status SW5502

Wireless Status

Default Information:	
SSID	
BSSID (AP MAC)	(Any)
Topology	Infrastructure
TxRate	Auto
Channel	Auto
Encryption	NONE
IP Address	192.168.1.1

Current Information:	
SSID	
BSSID (AP MAC)	(Any)
Topology	Infrastructure
TxRate	Auto
Channel	Auto
Encryption	NONE
Status	Disconnected

Fig. 3. 4

3.3.2 Site Monitor

Site Monitor allows users to view other wireless networks in the neighborhood, it also provides information on other access points such as SSID, Channel used, the RSSI (**R**eceived **S**ignal **S**trength **I**ndicator), Security and other parameters used by other access points. It can be helpful when setting SSID and Channel for this device to avoid SSID name and Channel conflict and prevent unexpected errors or degraded performance.

Bear in mind that it will take some time (approximately 10 seconds) for this option to gather information of the surrounding wireless networks, Fig. 3. 5.



Fig. 3. 5

System Status > Site Monitor **SW5502**

Site Monitor

SSID	Mode	Channel	Authentication	Encryption	Mbps	Signal
_PocketAP_C79B4A	b/g/n	1,5	WPA-PSK	TKIP/AES	150	96
ATOP_MIFI_111ds	b/g	1	WPA2	TKIP	54	62
banmu02	b/g	6	WPA2-PSK	TKIP	54	98
ATOP-S-Print	b/g/n	6	WPA2-PSK	AES	300	100
Guest	b/g/n	6	WPA2-PSK	AES	300	93
MitraStar00000	b/g/n	11	WPA-PSK	TKIP/AES	144	28
-canon	b/g/n	10,6	OPEN	WEP	300	39
AW55XX	a/n	149,153	OPEN	NONE	300	91

Fig. 3. 6

3.4 Network Settings

The SW550X series has the ability for dual connections, i.e., WLAN and LAN at the same time. It can also get IP information automatically from a DHCP server as well, just check “**Obtain an IP Address Automatically**” for it; or enter the values manually if known.

Note that under the Wireless Client mode, you will see two separate interfaces, LAN and WLAN. You need to configure them separately into different subnets and choose the interface that should be the **Default Gateway** (Fig. 3. 7).

Network Settings		SW5502
Network Settings		
LAN interface		
DHCP	<input type="checkbox"/>	Obtain an IP Address Automatically
IP Address	<input type="text"/>	10.0.160.120
Subnet Mask	<input type="text"/>	255.255.0.0
Default Gateway	<input type="text"/>	10.0.0.254
Wireless LAN interface		
DHCP	<input type="checkbox"/>	Obtain an IP Address Automatically
IP Address	<input type="text"/>	192.168.1.1
Subnet Mask	<input type="text"/>	255.255.255.0
Default Gateway	<input type="text"/>	192.168.1.254
Default Gateway		
Default Gateway Select	<input checked="" type="radio"/>	WLAN <input type="radio"/> LAN
DNS Server		
Preferred DNS	<input type="text"/>	168.95.1.1
Alternate DNS	<input type="text"/>	

* The IP subnets of Wireless and Wired interface must be in different subnets.

Fig. 3. 7

- **Default Gateway Selection** specifies whether you are intending to use wireless or LAN interface as the default gateway. The selected interface is usually the one that is connected to a gateway or Internet. Settings from one of them will not be applicable to

the other, i.e., if the WLAN is selected over the LAN then IP, Subnet mask, etc., on the LAN side will be OFF. You can still however be able to change the values of the one not in use and save those parameters.

Under the AP Client mode, you will only see one bridged interface and the default gateway selection is unnecessary (Fig. 3. 8).

The screenshot shows a web interface for 'Network Settings' on device 'SW5502'. It is divided into two main sections: 'LAN & WLAN interfaces' and 'DNS Server'. The 'LAN & WLAN interfaces' section includes a checkbox for 'Obtain an IP Address Automatically' (which is unchecked), and input fields for 'IP Address' (10.0.160.120), 'Subnet Mask' (255.255.0.0), and 'Default Gateway' (10.0.0.254). The 'DNS Server' section includes input fields for 'Preferred DNS' (168.95.1.1) and 'Alternate DNS' (empty). A red asterisk note at the bottom states: '* The IP subnets of Wireless and Wired interface must be in different subnets.' At the bottom of the form are two buttons: 'Save & Apply' and 'Cancel'.

LAN & WLAN interfaces	
DHCP	<input type="checkbox"/> Obtain an IP Address Automatically
IP Address	10.0.160.120
Subnet Mask	255.255.0.0
Default Gateway	10.0.0.254

DNS Server	
Preferred DNS	168.95.1.1
Alternate DNS	

* The IP subnets of Wireless and Wired interface must be in different subnets.

Save & Apply Cancel

Fig. 3. 8

With the exception of the above mentioned, the rest of the settings are self-explanatory.

3.5 Wireless

3.5.1 Basic Settings

To set up a wireless network, several parameters are needed as shown in Fig. 3. 9.

Wireless > Basic Settings		SW5502
Basic Settings		
Radio Off	<input type="checkbox"/> Enabled	
SSID	<input type="text"/>	<input type="button" value="scan network"/>
BSSID(MAC Address)	(Any) <input type="text"/>	<input type="checkbox"/> Enabled
WPS BUTTON	<input type="button" value="Start WPS PBC"/>	
Topology	Infrastructure ▾	
Band mode	Auto ▾	
TxRate	Best (auto) ▾	
Channel	1 ▾	
BandWidth	40MHz ▾	
Secondary Channel	5 ▾	
Authentication Mode	OPEN ▾	
Encryption Type	NONE ▾	
WEP Key		
	<input checked="" type="radio"/> Key 1: HEX (10 or 26 digits) ▾	0123456789
	<input type="radio"/> Key 2: HEX (10 or 26 digits) ▾	0123456788
	<input type="radio"/> Key 3: HEX (10 or 26 digits) ▾	0123456787
	<input type="radio"/> Key 4: HEX (10 or 26 digits) ▾	0123456786
WPA-PSK/WPA2-PSK		
Passphrase	<input type="text"/>	<input checked="" type="checkbox"/> Hide
WPA2(with Radius)		
User	SWXXXXX	
Password	<input type="password"/>	
Certificates	<input type="text"/> <input type="button" value="Browse..."/>	
	<input type="button" value="Upload CA certificate"/>	<input type="button" value="Upload Client certificate"/>
	<input type="button" value="Show Certificates Information"/>	
Private key password	<input type="password"/>	
<input type="button" value="Save & Apply"/> <input type="button" value="Temporary Apply"/> <input type="button" value="Cancel"/>		

Fig. 3. 10

SSID	MAC Address	T	Mode	Channel	Authentication	Encryption	*Mbps	Signal%
<input type="radio"/> TP-LINK_PocketAP_C79B4A	EC:88:8F:C7:9B:4A	Infra	b/g/n	1,5	WPA-PSK	TKIP/AES	150	91
<input type="radio"/> ATOP_MIFI_111ds	00:60:E9:0A:C4:F1	Infra	b/g	1	WPA2	TKIP	54	32
<input type="radio"/> banmu01	00:26:5A:F3:DC:DF	Infra	b/g/n	1,5	WPA-PSK	TKIP	300	22

T is Topology (Infra = Infrastructure, Adhoc)
Channel is listed as Primary Channel, Secondary Channel

Fig. 3. 11



Attention

- We recommend using LAN interface to setup Wireless Configurations to avoid disconnection issues. The Web UI might freeze or lock up if the setup is made using the wireless interface because the connection would be lost whenever wireless settings are changed. It might take some time for the device to attach to the Access Point with new settings.
- If you click on “Temporary Apply”, the changes would be applied at the runtime level and the wireless settings would be lost after reboot.

Default Settings in Infrastructure Mode:

Table 3. 1

Caption	Default
Radio Off	Disabled (box not checked)
SSID	Null
BSSID (MAC Address)	Any (unless enabled)
Topology	Infrastructure
Band Mode	Automatic Detection
Tx Rate (transmission rate)	Best (auto)
Channel	Automatic Detection
Bandwidth ¹	Automatic Detection
Secondary Channel	Automatic Detection
Authentication Mode	OPEN
Encryption Type	NONE

Default Settings in Adhoc Mode:

Table 3. 2

Caption	Default
Radio Off	Disabled (box not checked)
SSID	Null
BSSID (MAC Address)	Any (unless enabled)
Topology	Ad-Hoc
Band Mode	802.11a
Tx Rate (transmission rate)	Best (auto)
Channel	36
Bandwidth ¹	20 MHz
Secondary Channel	Disabled
Authentication Mode	OPEN
Encryption Type	NONE

- **Radio Off:** when enabled, this allows the user to turn off the wireless completely.
- **SSID:** specifies the SSID (network name) that SW550X should connect to wirelessly. There is a “**Scan Network**” button to the right of the empty box, this button makes it possible to look for available wireless networks to attach to. Once clicked, it will start

scanning and prompt a window.

- **BSSID:** this refers to the Access Point MAC address on which the SW550X should connect to. Enabling this option will lock SW550X to that Access Point, so SW550X would not roam to another Access Point with the same SSID.
- **WPS BUTTON:** the acronym stands for Wi-Fi Protected Setup, PBC stands for Push Button Configuration. To use this feature, first trigger the WPS process in the Access Point and click on the WPS PBC button on SW550X's UI. The AP and the SW550X should connect automatically. Note that the topology set in this case should be infrastructure and the Wireless Mode should be Auto so the WPS can work.
- **Topology:** Infrastructure (for connecting to an Access Point) or Adhoc (for connecting to a wireless client).
- **Band Mode:** 802.11b, 802.11b/g, 802.11b/g/n, 802.11a, and 802.11a/n are available. We suggest leaving this option to **Auto** for SW550X to sense the best available mode.
- **Tx Rate:** different rates are available, it is suggested to leave this to **Best (auto)**. This option is disabled when the band mode is set to Auto.
- **Channel:** the available channels would depend on the band mode and the regulatory domain selected in the Wireless Advanced Settings. This option is disabled when the band mode is set to Auto.
- **Bandwidth:** select between 20 MHz or 40 MHz; the latter fills a larger spectrum, hence it provides a better throughput if it is allowed by the Access Point. It is not recommended to use 40 MHz@2.4 GHz (802.11b/g/n).
- **Secondary Channel:** the second channel that SW550X uses when the 40 MHz bandwidth is enabled.
- **Authentication Mode:** Select between OPEN, WPA-PSK, WPA2-PSK, WPA2 (PEAP), WPA2(EAP-TLS), and WPA2(EAP-TTLS).
- **Encryption Type:** Select between WEP, TKIP and AES. Please be aware that WEP and TKIP are not supported by the 802.11n standard, so the wireless link speed would be limited to 54Mbps.
- **WEP Key:** Enable when Authentication is set to OPEN and Encryption is set to WEP. Up to 4 different hexadecimal or ASCII keys can be entered in this section.
- **WPA-PSK/WPA2-PSK Passphrase:** Enable when Authentication is set to WPA-PSK or WPA2-PSK. It can be between 8 and 63 characters long.
- **WPA2 (with RADIUS):** Depending on the Authentication Mode selected, different fields would be enabled. **WPA2 (PEAP)** would require you to provide the user, password, and the certificates. **WPA2 (EAP-TLS)** would require you to provide the certificates and private key password. **WPA2 (EAP-TTLS)** would require you to provide the user,

password, and the certificates. Please note that only *.pem certificates are supported.

Please remember that 2.4 GHz frequency is easily interfered by other devices that operate in the same region (namely, Bluetooth, Zigbee, Microwave, etc.) so it is better to choose the 802.11a/n which operates in the 5 GHz when your network allows it.

Steps to Connect to an Access Point

Input the SSID of the connecting Access Point or you can use the “Scan network” to have SW550X grab the necessary wireless information of surrounding access points in the device’s coverage area, please be patient as this process might take as long as 10 seconds.

Once it has finished scanning, names and basic properties of available networks will be shown as in Fig. 3. 11. After this, you can now select an AP from the list and its settings would load automatically to the device’s UI.

If no wireless networks have been found as shown in Fig. 3. 12.

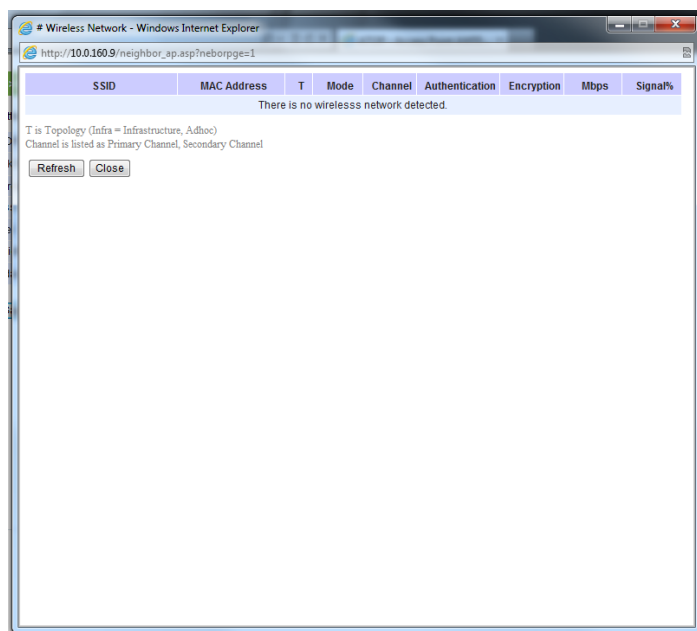

Fig. 3. 12

3.5.2 Advanced Settings

Provides details on wireless network parameters for performance tuning. Changes in this section may affect overall performance, so caution is recommended, if you are not clear of what you are doing please refrain from altering them, Fig. 3. 13.

Wireless > Advanced Settings		SW5502
Advanced Settings		
Fast Handoff	<input type="checkbox"/> Enabled	
Fast Roaming	<input type="checkbox"/> Enabled	
Roaming Threshold	<input checked="" type="radio"/> Low (25%/~80) <input type="radio"/> Normal (50%/~70) <input type="radio"/> High (75%/~60)	
Tx Power	100 ▾ %	
*Regulatory Domain	US (FCC5_FCCA) ▾	
Gratuitous ARP	Disabled ▾	5 minutes
STP	Disabled ▾	Forward Delay 4 seconds

Different regulatory domains will result in different channels/frequencies being allowed

Fig. 3. 13

- **Fast Handoff** – Atop’s proprietary protocol to speed up roaming between AW5500s in addition to Fast Roaming. Enable to allow AW5500 to share its neighboring AW5500 information to SW550X to further reduce its roaming time.
- **Fast Roaming** – Enable to allow SW550X to scan for available Access Points in the background to speed up roaming when necessary.
- **Roaming Threshold** – Determine when SW550X should try to connect to another Access Point when the wireless signal falls below the selected range.

- **Tx Power** – is the SW550X's **Transmission Power**; the transmission power can be reduced to prevent wireless interference to other wireless networks.
- **Gratuitous ARP** – Enable to periodically send out an ARP response automatically to announce that SW550X is in the network. The frequency in minutes could be set in the nearby box.
- **STP** – The **Spanning Tree Protocol** is only available in the AP Client mode. Enable this option if STP is enabled in your network to prevent network loops. When disabled, SW550X will not forward STP BPDUs.

3.6 Serial

3.6.1 COM Configuration

Detail on connectivity protocols and its settings are given in [Link Modes and Applications](#); this section will only focus on the serial settings.

Serial > COM1
SW5502

COM 1 Port Settings

LINK Mode
 To choose specific working mode for COM 1 port.

TCP Server
 TCP Client
 UDP

<i>TCP Server</i>	
Application	RAW
IP Filter	<input type="checkbox"/> Enable
Source IP	0 . 0 . 0 . 0
Local Port	4660
Maximum Connection	1
Response Behavior	<input type="radio"/> Request & Response Mode <input type="radio"/> Reply to requester only <input checked="" type="radio"/> Reply to all <input checked="" type="radio"/> Transparent Mode

To configure COM 1 port parameters.

<i>Serial Settings</i>	
Serial Interface	<input checked="" type="radio"/> RS232 <input type="radio"/> RS422 <input type="radio"/> RS485
Baud Rate	9600 bps
Parity	<input checked="" type="radio"/> None <input type="radio"/> Odd <input type="radio"/> Even <input type="radio"/> Mark <input type="radio"/> Space
Data bits	<input type="radio"/> 5 bits <input type="radio"/> 6 bits <input type="radio"/> 7 bits <input checked="" type="radio"/> 8 bits
Stop bits	<input checked="" type="radio"/> 1 bit <input type="radio"/> 2 bits
Flow Control	<input checked="" type="radio"/> None <input type="radio"/> Xon/Xoff <input type="radio"/> RTS/CTS

Fig. 3. 14

3.6.2 COM Configuration

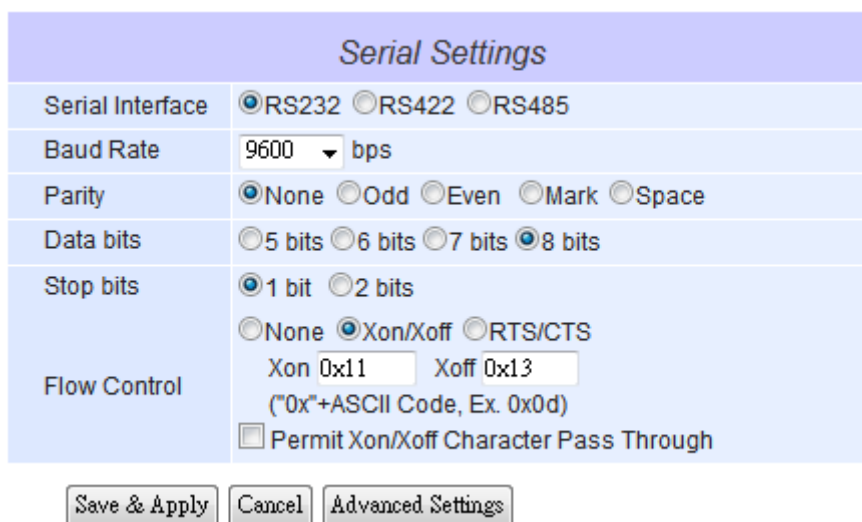

The image shows a 'Serial Settings' configuration window. It has a light blue header with the title 'Serial Settings'. Below the header are several rows of configuration options:

- Serial Interface:** Three radio buttons for RS232 (selected), RS422, and RS485.
- Baud Rate:** A dropdown menu showing '9600' and 'bps'.
- Parity:** Five radio buttons for None (selected), Odd, Even, Mark, and Space.
- Data bits:** Four radio buttons for 5 bits, 6 bits, 7 bits, and 8 bits (selected).
- Stop bits:** Two radio buttons for 1 bit (selected) and 2 bits.
- Flow Control:** Three radio buttons for None (selected), Xon/Xoff, and RTS/CTS. Below these are two text input fields: 'Xon 0x11' and 'Xoff 0x13'. A note below the fields reads: '(*0x"+ASCII Code, Ex. 0x0d)'. At the bottom of this section is a checkbox labeled 'Permit Xon/Xoff Character Pass Through' which is currently unchecked.

At the bottom of the window are three buttons: 'Save & Apply', 'Cancel', and 'Advanced Settings'.

Fig. 3. 15

Configure serial settings in this page, Fig. 3. 15. Note that these settings need to match the ones in the serial device.

- **Serial Interface:** Select between RS-232, RS-422, and RS-485. Note that RS-485 refers to 2-Wire RS-485 and RS-422 is compatible with 4-Wire RS-485.
- **Baud Rate:** Select one of the baudrates from the dropdown box.
- **Parity / Data Bits / Stop Bits:** Configure them accordingly.
- **Flow Control:** Choose between No Flow Control, RTS/CTS (Hardware Flow Control), and Xon/Xoff (Software Flow Control). If Xon/Xoff is selected, Xon and Xoff characters are changeable. Defaults are 0x11 for Xon and 0x13 for Xoff. If the connecting program or serial device would like to receive the Xon/Xoff signals also, enable “**Permit Xon/Xoff Character Pass Through**”

3.6.3 COM Configuration: Advanced Settings

ADVANCED SETTINGS		
TCP	TCP Timeout	<input checked="" type="checkbox"/> Enable 3600 (0~60000) seconds
Delimiters	Serial to Network Packet Delimiter	<input checked="" type="checkbox"/> Interval timeout 2 (1~30000) ms <input checked="" type="radio"/> Auto(caculate by baudrate) <input type="radio"/> Manual setting <input type="checkbox"/> Max. Bytes 1452 (within one packet:1~1452 bytes) <input type="checkbox"/> Character 0x0d0a ("0x"+ASCII Code, Ex. 0x0d or 0x0d0a)
	Network to Serial Packet Delimiter	<input type="checkbox"/> Interval timeout 10 (1~30000) ms <input type="checkbox"/> Max. Bytes 1452 (within one packet:1~1452 bytes) <input type="checkbox"/> Character 0x0d0a ("0x"+ASCII Code, Ex. 0x0d or 0x0d0a)
	Character Send Interval	<input type="checkbox"/> Enable 0 (0~1000) ms
	Response Interval Timeout	<input checked="" type="checkbox"/> Enable 1000 (0~60000) ms (Work with Request & Response Mode only)
Serial	Serial FIFO	<input checked="" type="checkbox"/> Enable (Disabling this option at baud rates higher than 115200bps would result in data loss).
	Serial Buffer	<input checked="" type="checkbox"/> Empty serial buffer when a new TCP connection is established

Fig. 3. 16

TCP

- **TCP Timeout:** Specify the value in "TCP Timeout" to force SW550X actively close a TCP connection after some specific inactivity time (no packets). The default value for it is 3600 seconds. Disabling this option means SW550X would never actively close an established connection.

Delimiters

- **Serial to Network Packet Delimiter:** Packet delimiter is a way of packing data in the serial communication. It is designed to keep packets in track. SW550X provides three types of delimiter: Time Delimiter, Maximum Bytes and Character Delimiter. Note that the following delimiters (Interval, Max Byte and Character) are programmed in the OR logic. Meaning that if any of the three conditions were met, SW550X would transmit the serial data in its buffer over the network.
 - ◆ **Interval timeout:** SW550X will transmit the serial data in its buffer when the

specified time interval has reached and no more serial data comes in. The default value is calculated automatically based on the baud rate. If the automatic value results in chopped data, the timeout could be increased manually by switching to “Manual setting” and specifying a larger value.



Attention

Interval Timeout Manual Calculation

The optimal “Interval timeout” depends on the application, but it must be at least larger than one character interval within the specified baud rate. For example, assuming that the serial port is set to 1200 bps, 8 data bits, 1 stop bit, and no parity. In this case, the total number of bits needed to send a character is 10 bits, and the time required to transfer one character is $(10 \text{ (bits)}/1200 \text{ (bits/s)}) * 1000 \text{ (ms/s)} = 8.3 \text{ ms}$.

Therefore, you should set the “Interval timeout” to be larger than 8.3 ms. Rounding 8.3 ms to the next integer would get you 9 ms.

- ◆ **Max Byte:** SW550X will transmit the serial data in its buffer when the specified length has reached. Enable this option if you would like SW550X to queue the data until it reaches a specific length. This option is disabled by default.
- ◆ **Character:** SW550X will transmit the serial data in its buffer when it sees the incoming data include the specified character (in HEX format). This field allows one or two characters. If character delimiter is set to 0x0d, SW550X will push out its serial buffer when it sees 0x0d (carriage return) in the serial data. This option is disabled by default.
- **Network to Serial Packet Delimiter:** Same as the delimiters above, but controls data flow in the opposite direction. It will store data from the network interface in the queue and send it to over to the serial interface until one of the delimiter conditions is met.
- **Character Send Interval:** This option specifies the time gap between each character. When set to two second, SW550X would split the data in the queue and only transmit one character (byte) every two second. This option is disabled by default.
- **Response Interval Timeout:** This option only affects the Request & Response Mode and has no effect on the Transparent Mode. When TCP data is received (request) and

passed to Serial side, the device will wait for the set time before transferring another TCP data if the Serial side did not receive any data (response).

Serial

- **Serial FIFO:** By default, SW550X has its FIFO function enabled to optimize its serial performance. In some applications (particularly when the flow control is enabled), it may deem necessary to disable the FIFO function to minimize the amount of data that is transmitted through the serial interface after a flow off event is triggered to reduce the possibility of overloading the buffer inside the serial device. Please note that disabling this option on baud rates higher than 115200bps would reduce the data integrity noticeably.
- **Serial Buffer:** By default, SW550X will empty its serial buffer when a new TCP connection is established. This means that the TCP application will not receive buffered serial data during a TCP link breakage. To keep the serial data when there is no TCP connection and send out the buffered serial data immediately after a TCP connection is established, disable this option.

3.7 SNMP/ALERT Settings

The SNMP is used by network management software to monitor devices in a network to retrieve network status information and to configure network parameters. The SNMP Settings shows the configuration of this device so it can be viewed by third-party SNMP software as shown below, Fig. 3. 17.

SNMP/ALERT Settings
SW5502

SNMP/ALERT Settings

The *SNMP* is used in network management systems to monitor network-attached devices for conditions that warrant administrative attention.

Basic Data Objects	
System Contact	<input type="text" value="contact"/>
System Name	<input type="text" value="0060E90B4EB0"/>
System Location	<input type="text" value="location"/>
SNMP	<input type="checkbox"/> Enable
Read Community	<input type="text" value="public"/>
Write Community	<input type="text" value="private"/>
SNMP Trap Server	
SNMP Trap Server	<input type="text" value="0.0.0.0"/>

Event alert settings

Alert Type	Email	SNMP Trap
Cold start	<input type="checkbox"/>	<input type="checkbox"/>
Warm start	<input type="checkbox"/>	<input type="checkbox"/>
Wireless Disassociated	<input type="checkbox"/>	<input type="checkbox"/>
Wireless Associated	<input type="checkbox"/>	<input type="checkbox"/>
Authenticate failed	<input type="checkbox"/>	<input type="checkbox"/>
IP Address changed	<input type="checkbox"/>	
Password changed	<input type="checkbox"/>	

Fig. 3. 17

SW550X provides three SNMP fields, which are “**System Contact**”, usually used to specify

the device's contact information in case of emergency; "**System Name**", usually used to identify this device; and "**System Location**", usually used to specify the device location.

If you wish to make the device information available for public viewing/editing, **Enable** the SNMP function. Fill in the passphrase for the "**Read Community**", the group that is allowed to read the device information and fill in the passphrase for the "**Write Community**", the group that is allowed to read/modify the device information. By default SW550X comes in **public** for **Read Community** and **private** for **Write Community**. In case the device raises an alert due to any unexpected incident, a message will be dispatched to a SNMP trap server. Specify the **IP Address** of the **SNMP Trap Server** designed to collect all alert messages; any changes made will take effect after the device is restarted.

There are five events that will trigger the alarm; these alerts are useful for security control or security monitoring:

- **Cold Start**, when there is a power interruption.
- **Warm Start**, when the device resets.
- **Authentication Failure**, when an incorrect username or password is entered.
- **IP Address Changed**, when the device's IP is changed.
- **Password Changed**, when the administrator password is changed.

Any of the five events would trigger an alert. When enabled, an email alert would be sent to the designated address in the E-Mail Settings. A Trap alert would be sent to the designated Trap server in the SNMP Settings.

See [E-mail Settings](#), to specify the email addresses to which the alert message is sent.

3.8 E-mail Settings

In case the device raises an alert and/or warning message, it will send an email to the administrator's mailbox. **Email Settings** allows you to set up the device to be able to send an email. To set up the email sending, you need to put a **"Sender"** email address which will be the **"From"** on the email. Then, you fill in **"Receiver"** email address to which the email is sent. You can send the email to several recipients using Semicolon (;) to separate each email address. Next step is to set the **Email Server**. First, you fill in the **IP address** of a **Mail Server** in your local network. If the **Mail Server** needs a user authentication, you need to enable **"SMTP server authentication required"**, and fill in **Username** and **Password**. Please contact your network administrator for **Mail Server IP address** and the **Username** and **Password**, Fig. 3. 18. You can click on **"Send Test Mail"** to verify your mail settings.

E-mail Settings SW5502

E-mail Settings

E-mail Address Settings	
Sender	<input type="text"/>
Receiver	<input type="text"/> <small>Use a semicolon (;) to delimit the receiver's e-mail address.</small>

E-mail Server	
SMTP Server	<input type="text"/>
Authentication	<input type="checkbox"/> SMTP server authentication required.
User name	<input type="text"/>
Password	<input type="password"/>

Fig. 3. 18



Attention

It is also important to setup Default Gateway and DNS Servers in the Network Settings properly, so your SW550X can lookup DNS names and route the mails to the proper default gateway.

3.9 Log Settings

3.9.1 System Log Settings

The Syslog function is turned on by default and cannot be turned off. It is used to log system events and report to an external Syslog server if necessary.

Log Settings > System Log Settings SW5502

System Log Settings

Enable Log Event to Flash	<input type="checkbox"/> Enabled
Log Level	3: (LOG_ERR) ▼
Enable Syslog Server	<input type="checkbox"/> Enabled
IP Address	0.0.0.0
Syslog Server Service Port	514 (1~65535, default=514)

Fig. 3. 19

- **Enable Log Event to Flash:** this would write log events to the local flash, otherwise the logs would be cleared when the device restarts because they are stored in the RAM by default.
- **Log Level:** 3 (we only allow logging at this level).
- **Enable Syslog Server:** enabling this option would allow you to send Syslog events to a remote Syslog server.
- **Syslog Server IP:** please specify the remote Syslog Server IP.
- **Syslog Server Service Port:** please specify the remote Syslog Server Port.

3.9.2 COM Log Settings

Transmitted data could be logged for recording or debugging purposes. The logs could be reported to an external Syslog server as well.

COM Log Settings	
<input type="checkbox"/> Log Data Contents	Types <input checked="" type="radio"/> HEX <input type="radio"/> ASCII
COM Ports	<input type="checkbox"/> COM1 <input type="checkbox"/> COM2
Enable Syslog Server	<input type="checkbox"/> Enabled
IP Address	0.0.0.0
Syslog Server Service Port	514 (1~65535, default=514)

Fig. 3. 20

- **Log Data Contents:** if enabled, the COM logging function will log the content's data that is being transmitted and received (raw bytes). If disabled, COM logging function will only log data length to reduce system load.

Note: SW550X can store up to 1500 lines internally. A request or a response will consist of one line, data longer than 512 bytes will go into another line. You can retrieve the logs by using a **FTP Client**, FTP login is the same as the WebUI. They are located in **/var/log/logcomxx** (xx is the port number). When the reserved space is full, new logs will replace old logs. We strongly recommend sending COM logs to a remote Syslog server.

- **Data types:** select the logged data's format (HEX or ASCII).
- **COMx:** Select the ports to log.
- **Enable Syslog Server:** enabling this option would allow you to send COM logs to a remote Syslog server. You can send COM logs to the same Syslog server used previously for event logging.
- **Syslog Server IP:** please specify the remote Syslog server IP.
- **Syslog Server Service Port:** please specify the remote Syslog server Port.

3.9.3 Event Log

Display the current event log stored in the device.

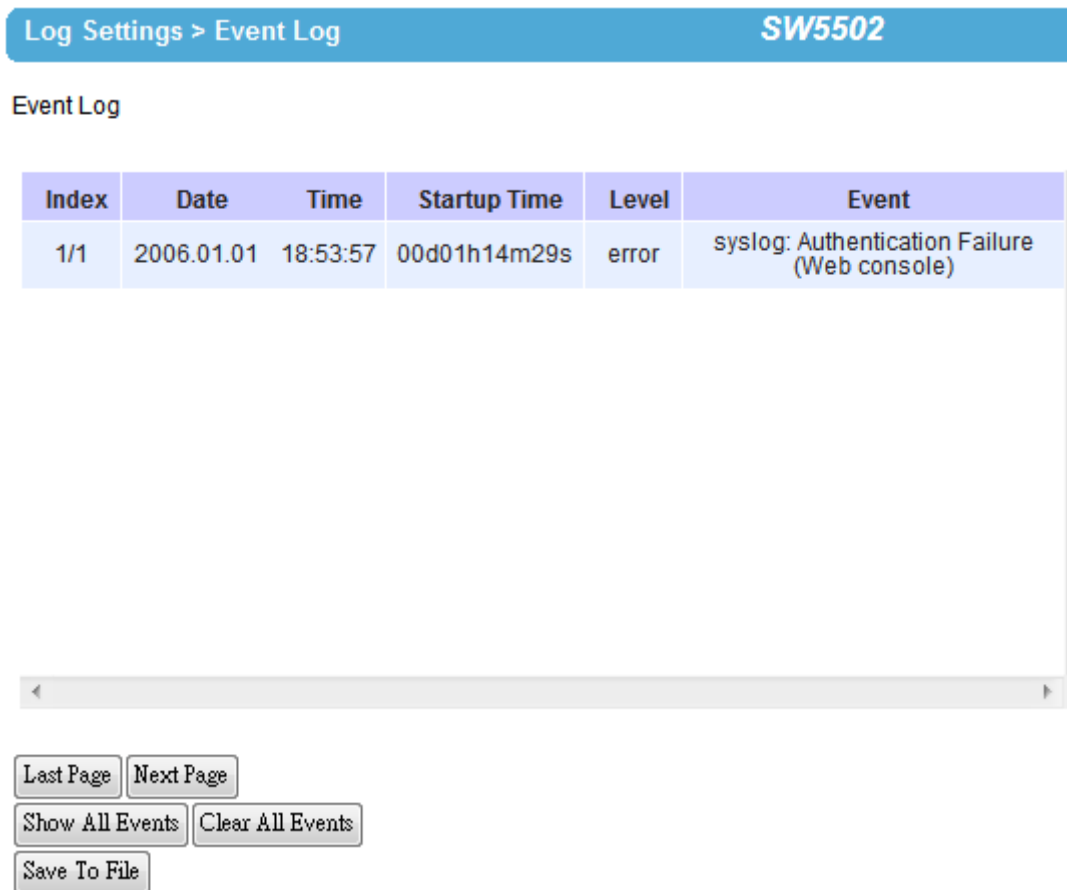

Fig. 3. 21

Click on "Last Page" to go to the last page. Click on "Show All Events" to show all events in one page. Click on "Clear All Events" to clear the events stored in the device. Click on "Save To File" to save all the events to a file locally.

3.9.4 COM Datalog

Display the current COM log stored in the device.

System Log > COM Datalog SW5502

COM Datalog

COM 1 Log

Index	Date	Time	Startup Time	Level	Event
1/7	2006.01.01	00:49:01	00d00h48m33s	info	: [COM1]R:(5)
2/7	2006.01.01	00:49:01	00d00h48m33s	info	: [COM1]T:(5)
3/7	2006.01.01	00:49:00	00d00h48m32s	info	: [COM1]R:(5)
4/7	2006.01.01	00:48:53	00d00h48m25s	info	: [COM1]R:(5) 48 65 6C 6C 6F
5/7	2006.01.01	00:48:53	00d00h48m25s	info	: [COM1]T:(5) 48 65 6C 6C 6F
6/7	2006.01.01	00:48:52	00d00h48m24s	info	: [COM1]R:(5) 48 65 6C 6C 6F
7/7	2006.01.01	00:48:52	00d00h48m24s	info	: [COM1]T:(5) 48 65 6C 6C 6F

Fig. 3. 22

You can select from the COMx dropdown box to display logs from different COM ports. The first three lines were set to log data length and the last four lines were set to log data content. Click on “**Last Page**” to go to the last page. Click on “**Show All Events**” to show all events in one page. Click on “**Clear All Events**” to clear the events stored in the device. Click on “**Save To File**” to save all the events to a file locally.

3.10 System Setup

3.10.1 Date/Time Settings

Date and time can be set manually, or using **Network Time Protocol (NTP)** to automatically synchronizes with a Time Server. For auto-synching check the box below **NTP Server Settings** “**Obtain date/time automatically**” proceeding then to fill the IP address or host name for it. If a hostname is entered, the DNS server must be configured properly; a Time Zone can be selected as well, Fig. 3. 23.

System Setup > Date/Time Settings		SW5502
Date/Time Settings		
The NTP (Network Time Protocol) is used to synchronize the date/time from the NTP server.		
Current Date/Time		
1 / Jan / 2006 19:04:39		
NTP Server Settings		
NTP	<input type="checkbox"/> Obtain date/time automatically	
NTP Server	<input type="text" value="pool.ntp.org"/>	
Time Zone	<input type="text" value="(GMT+08:00) Taipei"/>	
Manual Time Settings		
Date	<input type="text" value="01"/> / <input type="text" value="Jan"/> / <input type="text" value="2006"/>	
Time	<input type="text" value="19"/> : <input type="text" value="04"/> : <input type="text" value="37"/> (HH : MM : SS)	
<input type="button" value="Save & Apply"/> <input type="button" value="Cancel"/>		

Fig. 3. 23



Attention

It is also important to setup Default Gateway and DNS Servers in the Network Settings properly, so your SW550X can lookup DNS names and route the mails to the proper default gateway.

3.10.2 Admin Settings

The SW550X Series allows **User** and **password management**, the user's default is as "admin" and the password will be in blank as default; to set/change their value just follow the steps filling in the corresponding blanks and choose **Save & Apply** in the end, Fig. 3. 24.

System Setup > Admin Settings SW5502

Admin Settings

Set up the login user name and password.

Account Settings	
User name	<input type="text" value="admin"/>
Old password	<input type="text"/>
New password	<input type="text"/>
Repeat new password	<input type="text"/>

Web mode	
Web mode	<input checked="" type="radio"/> HTTP <input type="radio"/> HTTPS

Fig. 3. 24

There are two ways to access SW550X's Web UI. The first one being Hypertext Transfer Protocol (HTTP) and the other is Hypertext Transfer Protocol Secure (HTTPS). For enhanced security, it is recommended to use the encrypted HTTPS protocol. Note that HTTP uses port 80 while HTTPS uses the 443 port.

3.10.3 Firmware Upgrade

Updated firmware is provided by our company from time to time (for more information visit our News & Events webpage), to fix bugs and optimize performance. It is very important that the device must **NOT be turned off or powered off during the firmware upgrading, (please be patient as this whole process might take up to 7 minutes)**. Before upgrading the firmware, please make sure that the device has a reliable power source that will not be powered off or restarted during the upgrading process. To upgrade a new firmware, once downloaded, copy the new firmware file to your computer, and then click **“Browse”** to find the new firmware file as shown in Fig. 3. 25, then click **“Upload”**. The program will show the upload status, please wait until the uploading process is finished (the amount of time varies depending on the equipment used); the device will then proceed to restart itself.

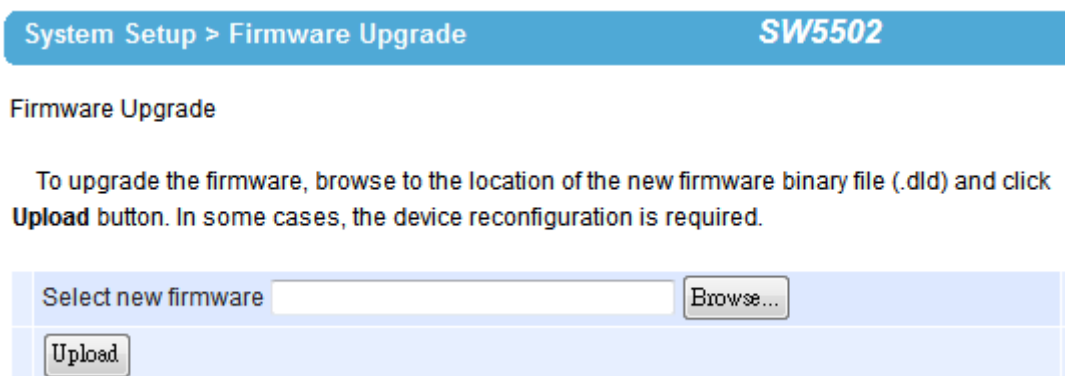

Fig. 3. 25

Note: if the firmware upgrade process fails and the device becomes unreachable, follow the TFTP Recovery procedure on the [Appendix](#).

3.10.4 Backup/Restore Setting

Once all the configurations are set and the device is working properly, you may want to back up your configuration. Backup can be used when the new firmware is uploaded and it is reset to a factory default settings, it is done to prevent accidental loading of incompatible old settings. The backup file could also be used to efficiently deploy multiple SW550X Series devices of similar settings by uploading these settings to the devices.

To backup your configuration, click “**Backup**”, and a pop-up dialog is prompted for saving the backup file on your computer. It is important **NOT to modify the saved configuration file by any editor. Any modification to the file may corrupt the file, and it may not be used for restore.** Please contact our authorized distributors for more information on this subject.

To restore the configuration backup, click “**Browse**” to locate the backup file, and then click “**Upload**” to upload the configuration backup file to the device. Once, the backup file is successfully uploaded; the device will restart, the time needed for this process may vary on the equipment used, Fig. 3. 26.

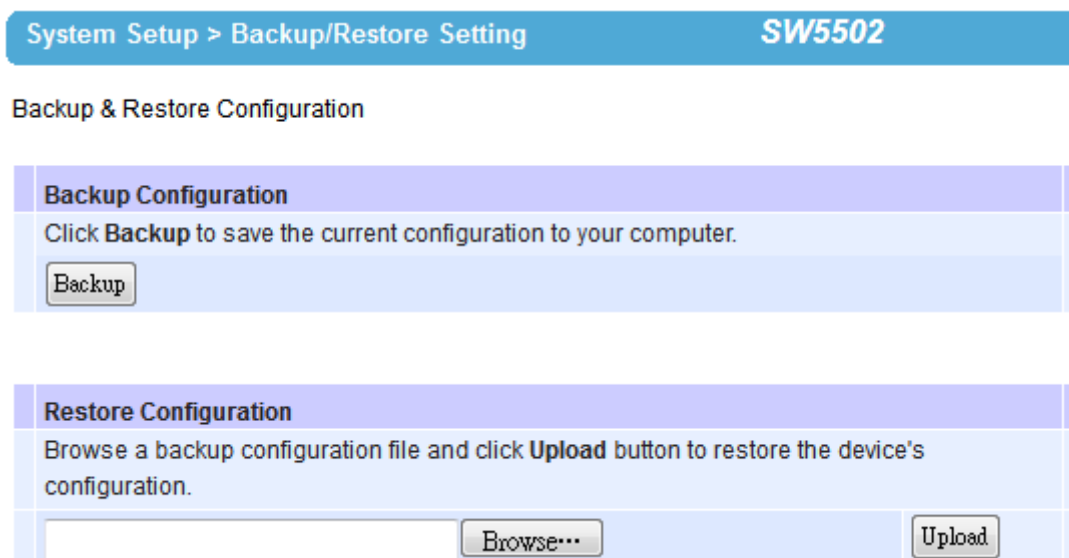

Fig. 3. 26

3.10.5 Management List

The Management List is used to filter the MAC address that has access to the Web management interface. When enabled, only the MAC addresses entered in the Access Control List below has access to the Web UI.

System Setup > Management List SW5502

Management List

The *Management List* is used to filter the MAC address that has access to the Web management interface.

Disable Management List
 Allow uses with MAC addresses listed below

Access Control List	
MAC Address 1	<input type="text"/>
MAC Address 2	<input type="text"/>
MAC Address 3	<input type="text"/>
MAC Address 4	<input type="text"/>
MAC Address 5	<input type="text"/>
MAC Address 6	<input type="text"/>
MAC Address 7	<input type="text"/>
MAC Address 8	<input type="text"/>
MAC Address 9	<input type="text"/>
MAC Address 10	<input type="text"/>

Fig. 3. 27

3.10.6 Ping

Use the Ping function to determine whether SW550X can reach the gateway or other devices in the network or not. This process takes around 20 seconds. Fig. 3. 28 represents a successful ping while Fig. 3. 29 means that the connecting device is not reachable.

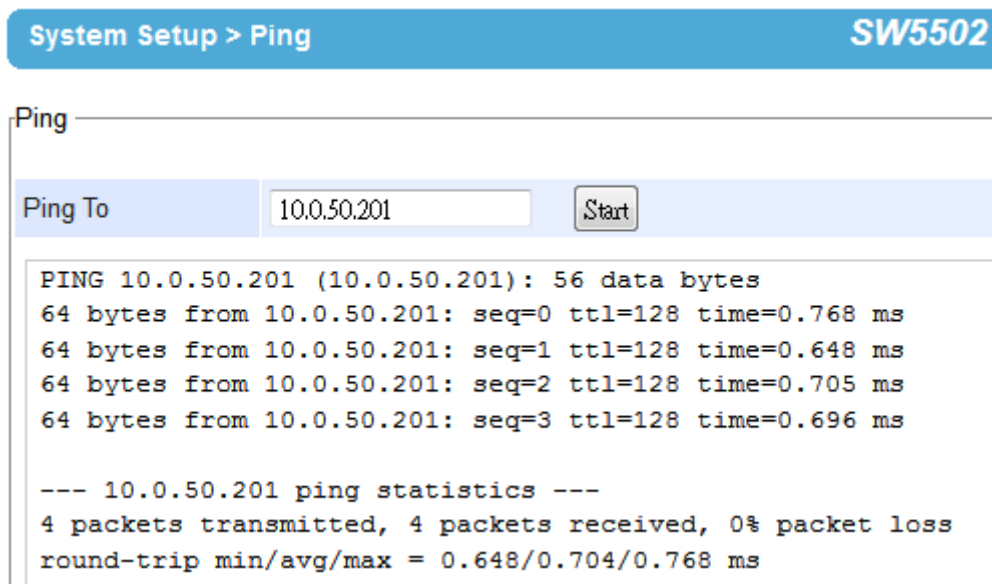

Fig. 3. 30

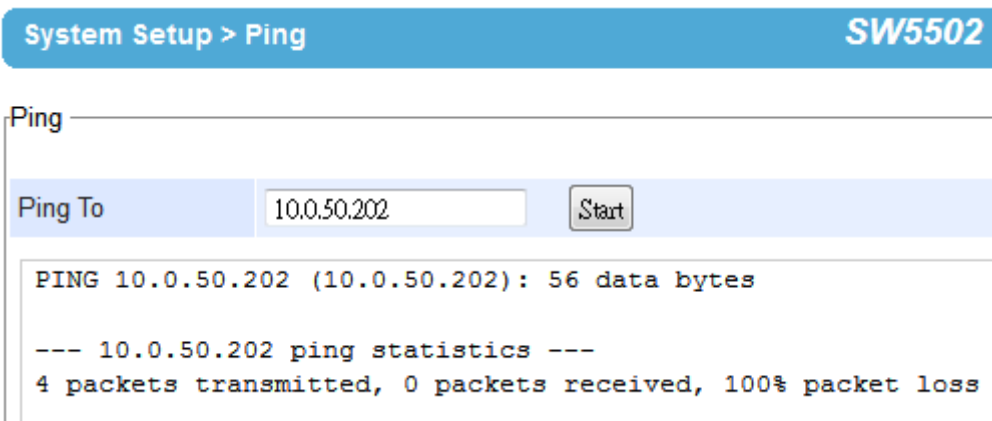

Fig. 3. 31

3.11 Reboot and Restore Default Settings

To manually reboot the device, you may click “**Reboot**”, after the click the device will restart. If a factory default setting is needed, the “**Reset**” checking box can be chosen, and then click on **Reboot**, Fig. 3. 32.

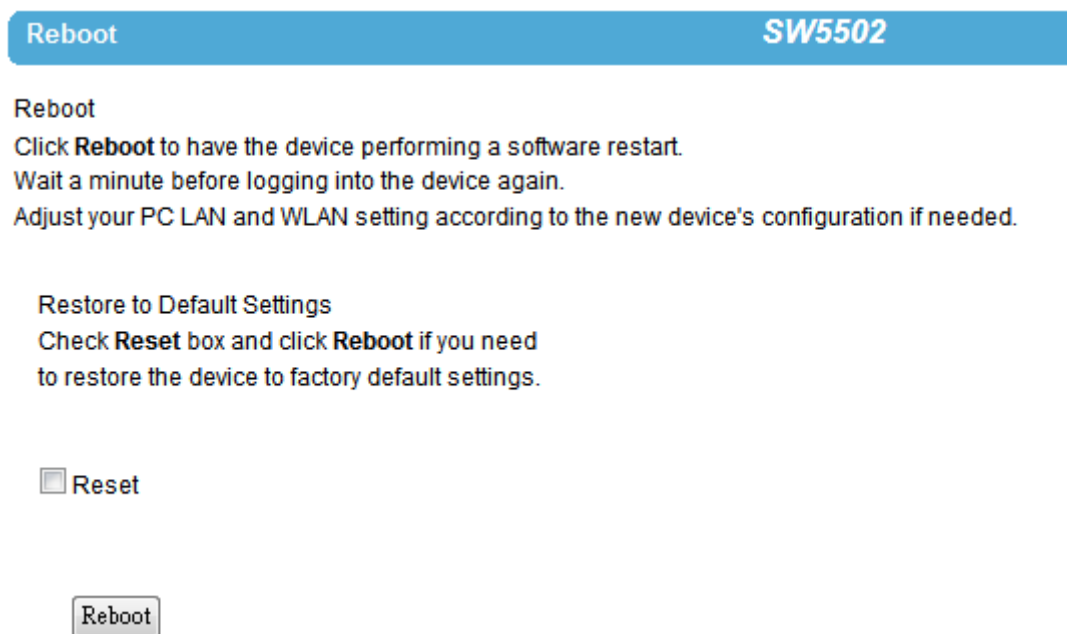

Fig. 3. 32

4 Link Modes and Applications

4.1 Link Mode Configuration

SW550X Series supports different Link Modes, which are TCP Server, TCP Client, and UDP. Under the three Link Modes, TCP Server can support RAW, Virtual COM, or Reverse Telnet applications. TCP Client can support Virtual COM application. In the upcoming sections, we will discuss how to setup different Link Modes properly.

LINK Mode

To choose specific working mode for COM 1 port.

TCP Server TCP Client UDP

Fig. 4. 1

4.1.1 Link Mode: Configure SW550X as a TCP Server

SW550X Series can be configured as a TCP server in a TCP/IP Network to listen for an incoming TCP client connection to a serial device. After the connection is established between the serial device server and the host computer, data can be transmitted in both directions; this also applies whenever the VCOM is running on server mode. Please be reminded that this is the device's default link mode.

TCP Server Mode

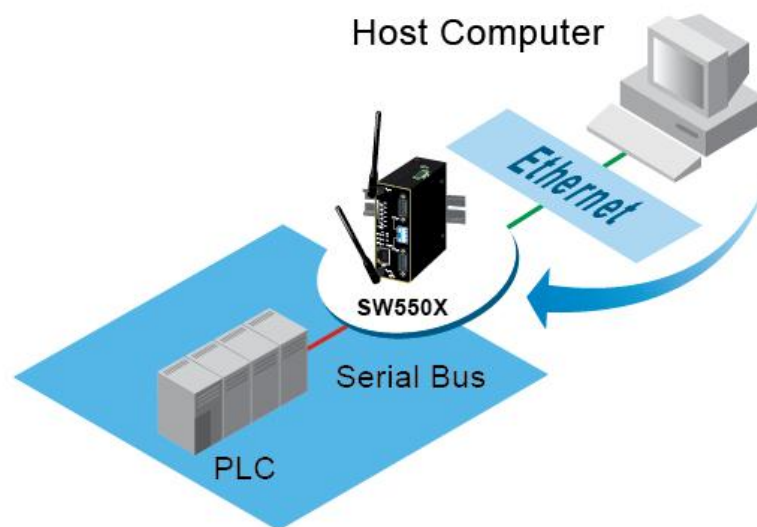

Fig. 4. 2

LINK Mode

To choose specific working mode for COM 1 port.

TCP Server TCP Client UDP

<i>TCP Server</i>	
Mode	RAW ▾
IP Filter	<input type="checkbox"/> Enable
Source IP	0 . 0 . 0 . 0
Local Port	4660
Maximum Connection	1 ▾
Response Behavior	<input type="radio"/> Request & Response Mode <input type="radio"/> Reply to requester only <input checked="" type="radio"/> Reply to all <input checked="" type="radio"/> Transparent Mode

Fig. 4. 3

SW550X defaults in TCP Server mode, there are additional connection settings that can be configured, Fig. 4. 3. By selecting the TCP Server mode, a TCP Client program should be prepared to connect to SW550X.

- Click on the “COM1” link on the left hand side.

Serial > COM1 SW5502

COM 1 Port Settings

LINK Mode
To choose specific working mode for COM 1 port.

TCP Server TCP Client UDP

TCP Server	
Application	RAW
IP Filter	<input type="checkbox"/> Enable
Source IP	0 . 0 . 0 . 0
Local Port	4660
Maximum Connection	1
Response Behavior	<input type="radio"/> Request & Response Mode <input type="radio"/> Reply to requester only <input checked="" type="radio"/> Reply to all <input checked="" type="radio"/> Transparent Mode

To configure COM 1 port parameters.

Serial Settings	
Serial Interface	<input checked="" type="radio"/> RS232 <input type="radio"/> RS422 <input type="radio"/> RS485
Baud Rate	9600 bps
Parity	<input checked="" type="radio"/> None <input type="radio"/> Odd <input type="radio"/> Even <input type="radio"/> Mark <input type="radio"/> Space
Data bits	<input type="radio"/> 5 bits <input type="radio"/> 6 bits <input type="radio"/> 7 bits <input checked="" type="radio"/> 8 bits
Stop bits	<input checked="" type="radio"/> 1 bit <input type="radio"/> 2 bits
Flow Control	<input checked="" type="radio"/> None <input type="radio"/> Xon/Xoff <input type="radio"/> RTS/CTS

Fig. 4. 4

- Select **TCP Server** in the Link Modes; TCP Server is the default link mode. Also in this section you will find the following options.
 - ◆ **Application**, there are 3 different communication applications here:
 - ◆ **RAW**, there is no protocol on this mode, meaning the data is passed transparently.
 - ◆ **Virtual COM**, the Virtual COM protocol is enabled on the device to communicate with a virtualized port from the client. It is possible to create a Virtual COM port on Windows/Linux in order to communicate with the device as a Client.
 - ◆ **Reverse Telnet**, used to connect the device and another serial device (usually a Terminal Server) with a Telnet program. Telnet programs in Windows / Linux usually require special handshaking to get the outputs and formatting show properly. The SW550X series will interact with those special commands (CR/LF commands) once Reverse Telnet is enabled.

- Enter the **Local Port**, this option specifies the port number that the server should listen to; it is used by the client to connect to the server. Default local port is 4660.
- For a detailed explanation of the response behavior, go to [Sec. 4.1.1](#). For serial settings, go to [Sec. 錯誤! 找不到參照來源。](#). For Advanced settings, go to [Sec. 錯誤! 找不到參照來源。](#).
- Scroll to the bottom of the page and click on “**Save & Apply**” button to save the changes.

Other important variables to consider are:

- **IP Filter**, enables the Source IP option below to block an IP address from accessing the COM port.
- **Source IP**, specifies the device’s Source IP which will be transmitting data to our Server. In other words, our Server will only allow data from this IP to flow (hence its own name implies Source IP); only one source is allowed.
- **Maximum Connection**, the number of devices/clients (max. of 4 clients), to be served is set in this section.
- **Response Behavior**, in which we will have as options:
 - ◆ **Request & Response Mode**, it determines how the device will proceed when it receives requests from connected hosts. Under this mode, the port will hold requests from all other connected hosts until the serial device replies or the **Response Interval timeout** takes into effect to discard it; however, unrequested data sent from the serial device would be forwarded to all connected hosts.
 - **Reply to requester only**, the port will reply to the connected host who requested the data only.
 - **Reply to all**, a reply is sent to all connected hosts.

- ◆ **Transparent mode**, the port will forward requests from all connected hosts to the serial device immediately and reply to all connected hosts once it receives data from the serial device.

Note: LINK1 is associated with COM1; LINK2 is associated with COM2, and so on.

4.1.2 Link Mode: Configure SW550X as a TCP Client

SW550X Series can be configured as a TCP client in TCP/IP Network to establish a connection with a TCP server in the host computer. After the connection is established, data can be transmitted between a serial device and a host computer in both directions; this also applies to Virtual COM running in the client mode.

TCP Client Mode

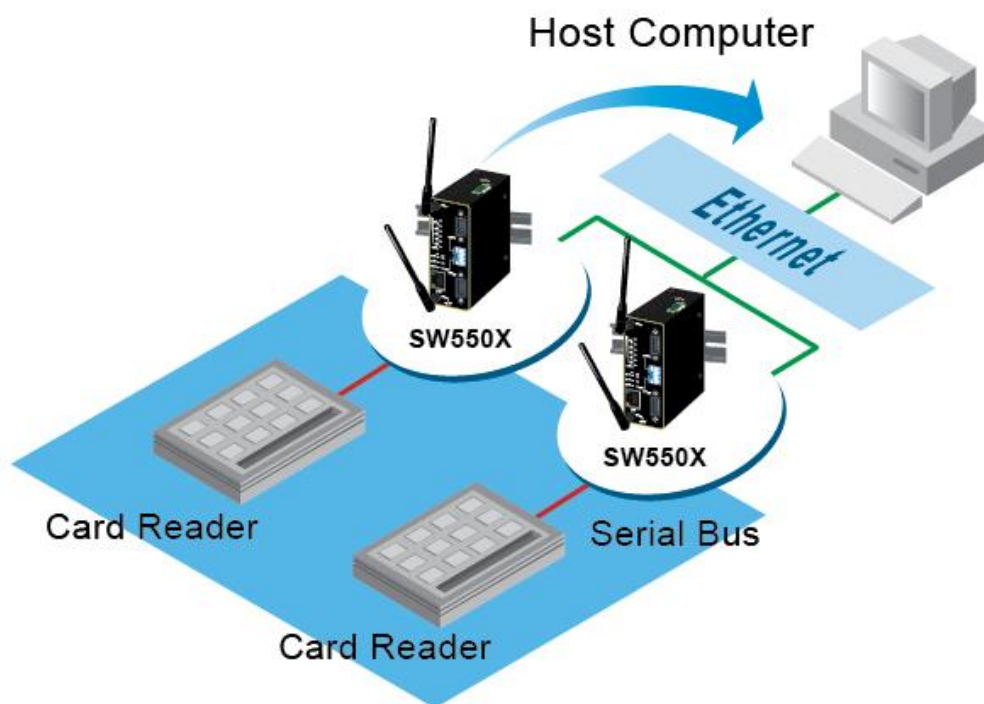

Fig. 4. 5

TCP Server TCP Client UDP

<i>TCP Client</i>	
Application	RAW
Destination IP 1	10 . 0 . 50 . 1
Destination Port 1	4660
Destination 2	<input type="checkbox"/> Enable
Destination IP 2	0 . 0 . 0 . 0
Destination Port 2	4660
Response Behavior	<input type="radio"/> Request & Response Mode <input type="radio"/> Reply to requester only <input checked="" type="radio"/> Reply to all <input checked="" type="radio"/> Transparent Mode

Fig. 4. 6

By selecting the TCP Client mode, it means that a TCP Server program should be prepared to connect to SW550X. Fig. 4. 6 shows all the settings provided for the TCP Client.

- Click on the “**COM1**” link on the left hand side.

Serial > COM1
SW5502

COM 1 Port Settings

LINK Mode
 To choose specific working mode for COM 1 port.

TCP Server
 TCP Client
 UDP

TCP Client

Application	RAW
Destination IP 1	10 . 0 . 50 . 1
Destination Port 1	4660
Destination 2	<input type="checkbox"/> Enable
Destination IP 2	0 . 0 . 0 . 0
Destination Port 2	4660
Response Behavior	<input type="radio"/> Request & Response Mode <input type="radio"/> Reply to requester only <input checked="" type="radio"/> Reply to all <input checked="" type="radio"/> Transparent Mode

To configure COM 1 port parameters.

Serial Settings

Serial Interface	<input checked="" type="radio"/> RS232 <input type="radio"/> RS422 <input type="radio"/> RS485
Baud Rate	9600 bps
Parity	<input checked="" type="radio"/> None <input type="radio"/> Odd <input type="radio"/> Even <input type="radio"/> Mark <input type="radio"/> Space
Data bits	<input type="radio"/> 5 bits <input type="radio"/> 6 bits <input type="radio"/> 7 bits <input checked="" type="radio"/> 8 bits
Stop bits	<input checked="" type="radio"/> 1 bit <input type="radio"/> 2 bits
Flow Control	<input checked="" type="radio"/> None <input type="radio"/> Xon/Xoff <input type="radio"/> RTS/CTS

Fig. 4. 7

- Select **TCP Client** in the Link modes.
- Only two communication modes are available here: RAW and Virtual COM which definitions are the same as above in [Sec. 4.1.1.](#)
- Enter the preferred **Destination IP** and **Port**. This should match the IP settings of the TCP Server program.
- Enable and enter Destination IP 2 and Port 2 if necessary. Two different servers can be set here (for redundancy), the second server has to be enabled by ticking the box.

- For a detailed explanation of the response behavior, go to [Sec. 4.1.1](#). For serial settings, go to [Sec. 錯誤! 找不到參照來源。](#). For Advanced settings, go to [Sec. 錯誤! 找不到參照來源。](#).
- Scroll to the bottom of the page and click on “**Save & Apply**” button to save the changes.

4.1.3 Link Mode: Configure SW550X in UDP

UDP is a faster but connectionless network protocol; it does not guarantee the delivery of network datagram. The SW550X Series can be configured to transfer data using unicast or multicast UDP from the serial device to one or multiple host computers, data can be transmitted between serial device and host computer in both directions.

There is no **server** or **client** concept on this protocol, they are called **peers** or **nodes**. So here you only need to specify the **Local Port** that we should listen to and specify the **Destination IPs** of the remote **UDP nodes**.

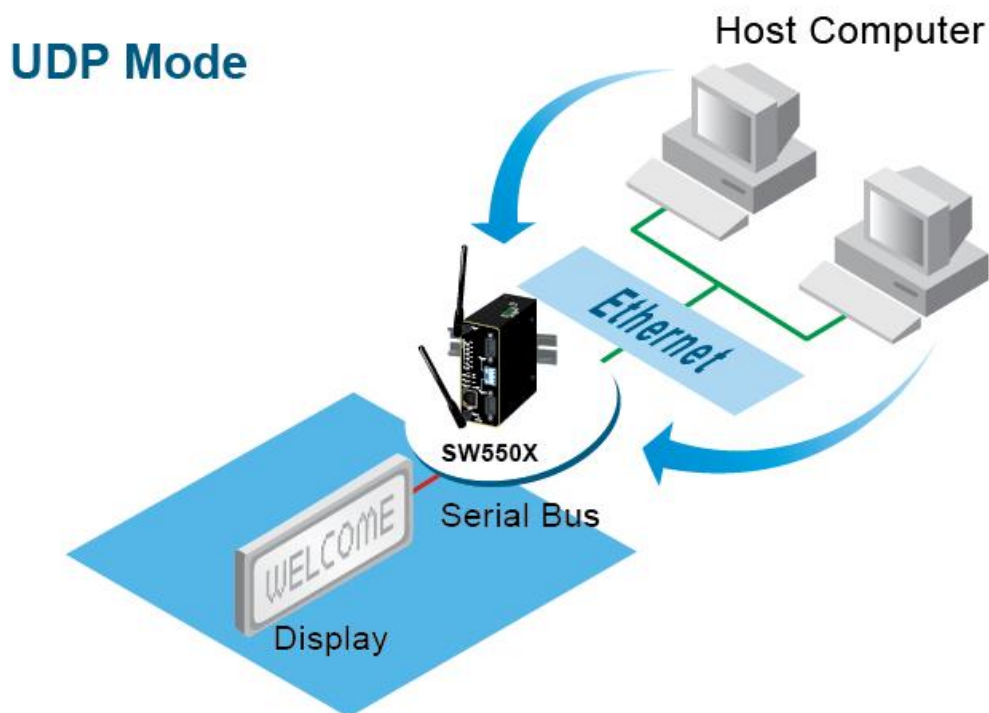

Fig. 4. 8

LINK Mode

To choose specific working mode for COM 1 port.

TCP Server TCP Client UDP

UDP			
Local Port: 4660			
<input checked="" type="checkbox"/> Destination IP Address 1	10 . 0 . 50 . 1 ~ 100	Port:	4660
<input type="checkbox"/> Destination IP Address 2	0 . 0 . 0 . 0 ~ 0	Port:	4660
<input type="checkbox"/> Destination IP Address 3	0 . 0 . 0 . 0 ~ 0	Port:	4660
<input type="checkbox"/> Destination IP Address 4	0 . 0 . 0 . 0 ~ 0	Port:	4660

Fig. 4. 9

SW550X also supports connectionless UDP protocol compared to the connection-oriented TCP protocol. Please be aware that even though UDP provides better efficiency in terms of response time and resource usage, it does not guarantee data delivery. It is recommended to utilize UDP only with cyclic polling protocols where each request is repeated and independent, such as Modbus Protocol. Fig. 4. 9 shows the UDP settings.

- Click on the “**COM1**” link on the left hand side.

Serial > COM1
SW5502

COM 1 Port Settings

LINK Mode
 To choose specific working mode for COM 1 port.

TCP Server
 TCP Client
 UDP

UDP

Local Port: 4660

<input checked="" type="checkbox"/> Destination IP Address 1	10 . 0 . 50 . 1 ~ 10	Port: 4660
<input type="checkbox"/> Destination IP Address 2	0 . 0 . 0 . 0 ~ 0	Port: 4660
<input type="checkbox"/> Destination IP Address 3	0 . 0 . 0 . 0 ~ 0	Port: 4660
<input type="checkbox"/> Destination IP Address 4	0 . 0 . 0 . 0 ~ 0	Port: 4660

To configure COM 1 port parameters.

Serial Settings

Serial Interface	<input checked="" type="radio"/> RS232 <input type="radio"/> RS422 <input type="radio"/> RS485
Baud Rate	9600 bps
Parity	<input checked="" type="radio"/> None <input type="radio"/> Odd <input type="radio"/> Even <input type="radio"/> Mark <input type="radio"/> Space
Data bits	<input type="radio"/> 5 bits <input type="radio"/> 6 bits <input type="radio"/> 7 bits <input checked="" type="radio"/> 8 bits
Stop bits	<input checked="" type="radio"/> 1 bit <input type="radio"/> 2 bits
Flow Control	<input checked="" type="radio"/> None <input type="radio"/> Xon/Xoff <input type="radio"/> RTS/CTS

Fig. 4. 10

- Select **UDP** in the Link Modes.
- **Destination IP and Port:** Specify the **Begin** and **End IP** here. Four groups of range IPs are allowed. This is the **IP** address of the UDP program and the **Port** it is listening to. Note that the maximum number of UDP nodes that SW550X can handle would highly depend on the traffic load. *We have tested that SW550X can handle up to 200 UDP nodes (baud rate 9600 bps, request interval 100ms, and data length 30bytes).*
- Enter the **Local Listening Port**. This is the port that SW550X should listen to. Match this setting in the UDP program (usually called destination port in the UDP program).
- For serial settings, go to **Sec. 錯誤! 找不到參照來源。**. For Advanced settings, go to **Sec. 錯誤! 找不到參照來源。**.
- Scroll to the bottom of the page and click on “**Save & Apply**” button to save the changes.

4.2 Link Mode Applications

4.2.1 TCP Server Application: Enable Virtual COM

SW550X will encapsulate control packets on top of the real data when Virtual COM is enabled. This will allow the Virtual COM port in the Windows/Linux system to access SW550X's COM ports. The benefit of using Virtual COM is that rewriting an existing COM program to read IP packets is unnecessary. In other words, it is possible to use an ordinary serial (COM) program. The conversion/virtualization of IP to COM is all done in the system driver transparently. Fig. 4.11. shows SW550X in TCP Server mode with Virtual COM enabled.

LINK Mode
To choose specific working mode for COM 1 port.

TCP Server TCP Client UDP

TCP Server	
Mode	Virtual COM ▾
IP Filter	<input type="checkbox"/> Enable
Source IP	0 . 0 . 0 . 0
Local Port	4660
Maximum Connection	1 ▾
Response Behavior	<input type="radio"/> Request & Response Mode <input type="radio"/> Reply to requester only <input checked="" type="radio"/> Reply to all <input checked="" type="radio"/> Transparent Mode

Fig. 4. 11

- Follow [Sec. 4.1.1](#) to configure SW550X in TCP Server mode properly.
- Click on the dropdown box of the **Application** option and switch to “**Virtual COM**” to enabled Virtual COM application in SW550X.
- Scroll to the bottom of the page and click on “**Save & Apply**” button to save the changes.
- Configure Virtual COM in the Operating System. For Windows, refer to [Chapter 5](#). Remember SW550X's IP address and the **Local Port** here in order to enter this information in Serial/IP Virtual COM's Control Panel later.

4.2.2 TCP Server Application: Enable RFC 2217

The underlying protocol of Virtual COM is based on RFC 2217, the Telnet COM Control Option. Therefore, it is possible to use RFC 2217 with SW550X in the TCP Server mode. To do so, refer to [Sec. 4.2.1](#) to enable Virtual COM, so that SW550X becomes aware of the commands. Note that there is no need to configure Virtual COM on the Operating System because Virtual COM ports would not be used.

4.2.3 TCP Client Application: Enable Virtual COM

It is also possible to run VCOM in TCP Client mode, Fig. 4. 12. It is usually easier to use Virtual COM in the Client mode if SW550X uses dynamic IP (DHCP) because setting a static IP address in Virtual COM's Control Panel in the Operating System is not possible.

LINK Mode

To choose specific working mode for COM 1 port.

TCP Server TCP Client UDP

TCP Client	
Application	Virtual COM
Destination IP 1	10 . 0 . 50 . 1
Destination Port 1	4660
Destination 2	<input type="checkbox"/> Enable
Destination IP 2	0 . 0 . 0 . 0
Destination Port 2	4660
Response Behavior	<input type="radio"/> Request & Response Mode <input type="radio"/> Reply to requester only <input checked="" type="radio"/> Reply to all <input checked="" type="radio"/> Transparent Mode

Fig. 4. 12

- Follow [Sec. 4.1.2](#) to configure SW550X in TCP Client mode properly.
- Click on the dropdown box of the **Application** option and switch to “**Virtual COM**” to enabled Virtual COM application in SW550X.
- Scroll to the bottom of the page and click on “**Save & Apply**” button to save the changes.
- Configure Virtual COM in the Operating System. For Windows, refer to [Chapter 5](#).

Remember the **Destination Port** here in order to enter this information in Serial/IP Virtual COM's Control Panel later.

4.2.4 TCP Client Application: Enable RFC 2217

The underlying protocol of Virtual COM is based on RFC 2217, the Telnet COM Control Option. Therefore, it is possible to use RFC 2217 with SW550X in the TCP Client mode. To do so, refer to [Sec. 4.2.3](#) to enable Virtual COM, so that SW550X becomes aware of the commands. Note that there is no need to configure Virtual COM on the Operation System because Virtual COM ports would not be used.

4.2.5 TCP Server Application: Configure SW550X as a Pair Connection Master

Pair Connection is useful when pairing up two serial devices over the Ethernet or when it is impossible to install Virtual COM in the serial device. Pair connection does require two SW550X to work in pair, one would be the Pair Connection Master and the other would be the Pair Connection Slave.

LINK Mode

To choose specific working mode for COM 1 port.

TCP Server TCP Client UDP

TCP Server	
Application	Pair Connection Master ▾
IP Filter	<input type="checkbox"/> Enable
Source IP	0 . 0 . 0 . 0
Local Port	4660
Maximum Connection	1 ▾
Response Behavior	<input type="radio"/> Request & Response Mode <input type="radio"/> Reply to requester only <input checked="" type="radio"/> Reply to all <input checked="" type="radio"/> Transparent Mode

Fig. 4. 13

- Follow [Sec. 4.1.1](#) to configure SW550X in TCP Server mode properly.
- Click on the dropdown box of the **Application** option and switch to “**Pair Connection Master**” to enabled Pair Connection application in SW550X.

- Scroll to the bottom of the page and click on “**Save & Apply**” button to save the changes.
- Remember Pair Connection Master’s IP address here in order to enter this information in the Slave later.
- Proceed to the [section below](#) to configure a Slave to connect to this Master.

4.2.6 TCP Client Application: Configure SW550X as a Pair Connection Slave

A **Pair Connection Slave**, is shown in Fig. 4. 14; it is necessary to pair up with a **Pair Connection Master**. Please setup a **Pair Connection Master** first before proceeding.

LINK Mode

To choose specific working mode for COM 1 port.

TCP Server TCP Client UDP

TCP Client	
Application	Pair Connection Slave ▾
Destination IP 1	10 . 0 . 50 . 1
Destination Port 1	4660
Destination 2	<input type="checkbox"/> Enable
Destination IP 2	0 . 0 . 0 . 0
Destination Port 2	4660
Response Behavior	<input type="radio"/> Request & Response Mode <input type="radio"/> Reply to requester only <input checked="" type="radio"/> Reply to all <input checked="" type="radio"/> Transparent Mode

Fig. 4. 14

- Follow [Sec. 4.1.2](#) to configure SW550X in TCP Client mode properly.
- Click on the dropdown box of the **Application** option and switch to “**Pair Connection Slave**” to enabled Pair Connection application in SW550X.
- Match the **Destination IP** with the settings of Pair Connection Master’s IP that was setup previously.
- Scroll to the bottom of the page and click on “**Save & Apply**” button to save the changes.

4.2.7 TCP Server Application: Enable Reverse Telnet

Reverse Telnet is useful if a telnet program is used to connect to SW550X and the serial interface of the SW550X is connected to a Terminal Server. Telnet programs in Windows/Linux require special handshaking to get the outputs and formatting show properly. SW550X will interact with those special commands (CR/LF commands) if Reverse Telnet is enabled.

LINK Mode

To choose specific working mode for COM 1 port.

TCP Server TCP Client UDP

TCP Server	
Mode	Reverse Telnet ▾
IP Filter	<input type="checkbox"/> Enable
Source IP	10 . 0 . 190 . 7
Local Port	4660
Maximum Connection	1 ▾
Response Behavior	<input type="radio"/> Request & Response Mode <input type="radio"/> Reply to requester only <input checked="" type="radio"/> Reply to all <input checked="" type="radio"/> Transparent Mode

Fig. 4. 15

- Follow [Sec. 4.1.1](#) to configure SW550X in TCP Server mode properly.
- Click on the dropdown box of the **Application** option and switch to “**Reverse Telnet**” to enabled telnet application in SW550X.
- Scroll to the bottom of the page and click on “**Save & Apply**” button to save the changes.

4.2.8 UDP Application: Multi-Point Pair Connection

It is also possible to setup pair connection in UDP mode to have more than one Pair Connection Master or Slave to communicate to each other. For example, it is possible to setup one Modbus Master and six Modbus Slaves in UDP, Fig. 4. 16. Note again that UDP does not guarantee data delivery and only data would be transmitted over Ethernet; other serial pings are not transmitted. If RS-232 along with flow control, it is recommended to use Multi-Point Pair Connection in TCP, see [Sec. 4.2.10](#).

Note: the destination IP and Port of the Slaves need to be equal to the Master's IP and Port. Local Listening Port of the Slaves need to be equal to the Master's Destination Port, see Table for an example.

Table 4. 1

	IP Address	Link Mode	Local Listening Port	Destination IP	Destination Port
SW5501 Master COM1	10.0.50.100	UDP	5000	10.0.50.200~10.0.50.203	5000
SW5501 Master COM1	10.0.50.100	UDP	5001	10.0.50.200~10.0.50.201	5001
SW5502 Slave 1 COM1	10.0.50.200	UDP	5000	10.0.50.100	5000
SW5502 Slave 1 COM2	10.0.50.200	UDP	5001	10.0.50.100	5001
SW5502 Slave 2 COM1	10.0.50.201	UDP	5000	10.0.50.100	5000
SW5502 Slave 2 COM2	10.0.50.201	UDP	5001	10.0.50.100	5001
SW5501 Slave 3 COM1	10.0.50.202	UDP	5000	10.0.50.100	5000
SW5501 Slave 4 COM1	10.0.50.203	UDP	5000	10.0.50.100	5000

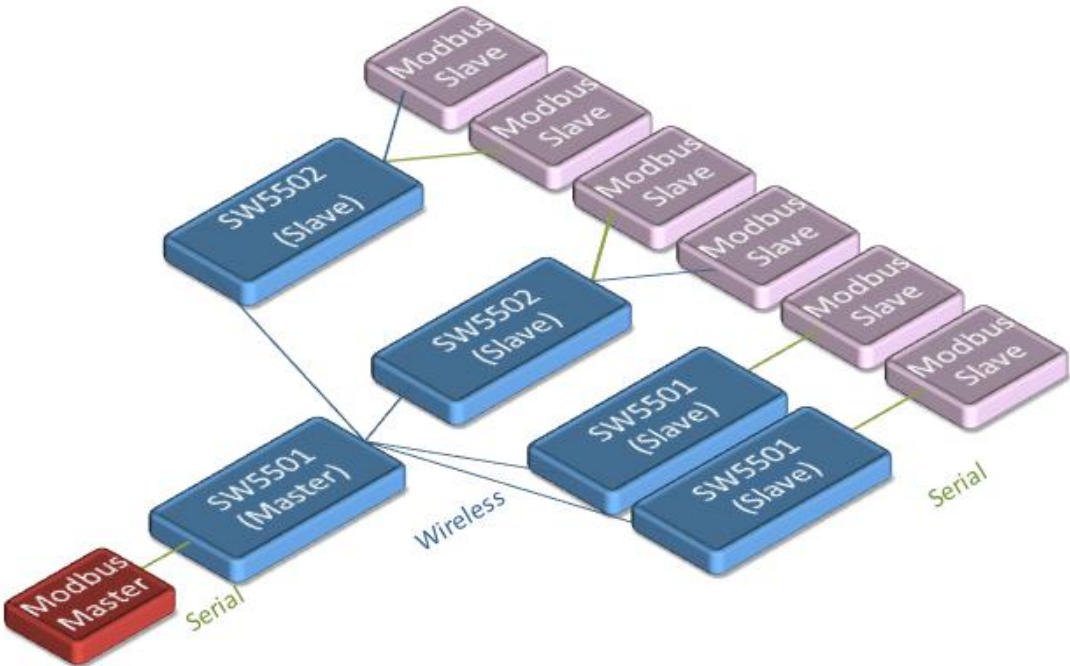

Fig. 4. 16

4.2.9 TCP Server Application: Multiple TCP Connections

The Multi-Connection option will allow up to a maximum of four TCP Client connections. Note that it is also possible to use this multi-connection feature in conjunction with other TCP Server applications, such as Virtual COM, Pair Connection, and Reverse Telnet. For example, enabling multi-connection along with Pair Connection will result in Multi-Point Pair Connection in TCP mode ([Sec. 4.2.10](#)). For more information on Response behavior please go to [Sec. 4.1.1](#).

LINK Mode
 To choose specific working mode for COM 2 port.

TCP Server
 TCP Client
 UDP

<i>TCP Server</i>	
Mode	RAW ▾
IP Filter	<input type="checkbox"/> Enable
Source IP	0 . 0 . 0 . 0
Local Port	4660
Maximum Connection	4 ▾
Response Behavior	<input type="radio"/> Request & Response Mode <input type="radio"/> Reply to requester only <input checked="" type="radio"/> Reply to all <input checked="" type="radio"/> Transparent Mode

Fig. 4. 17

4.2.10 TCP Server Application: Multi-Point TCP Pair Connections

The difference between Multi-Point TCP Pair Connection and Multi-Point UDP Pair Connection is that the TCP implementation would also exchange flow control pins for RS-232. However, the TCP Server is limited to a maximum of four connections. If there are four serial devices and they don't use flow control pins with RS-232 or RS-485, it is possible to setup pair connection in UDP mode, [Sec. 4.2.8](#). After multi-connection is enabled in the WebUI, refer to the following table to setup Pair Connection as in Fig. 4. 18.

Table 4. 2

	IP Address	Link Mode	Application	Local Listening Port	Destination IP	Destination Port
SW5501 Master COM1	10.0.50.100	TCP Server	Pair Connection Master	4660	-	-
SW5502 Slave 1 COM1	10.0.50.200	TCP Client	Pair Connection Slave	-	10.0.50.100	4660
SW5502 Slave 1 COM2	10.0.50.200	TCP Client	Pair Connection Slave	-	10.0.50.100	4660
SW5501 Slave 2 COM1	10.0.50.201	TCP Client	Pair Connection Slave	-	10.0.50.100	4660
SW5501 Slave 3 COM1	10.0.50.202	TCP Client	Pair Connection Slave	-	10.0.50.100	4660

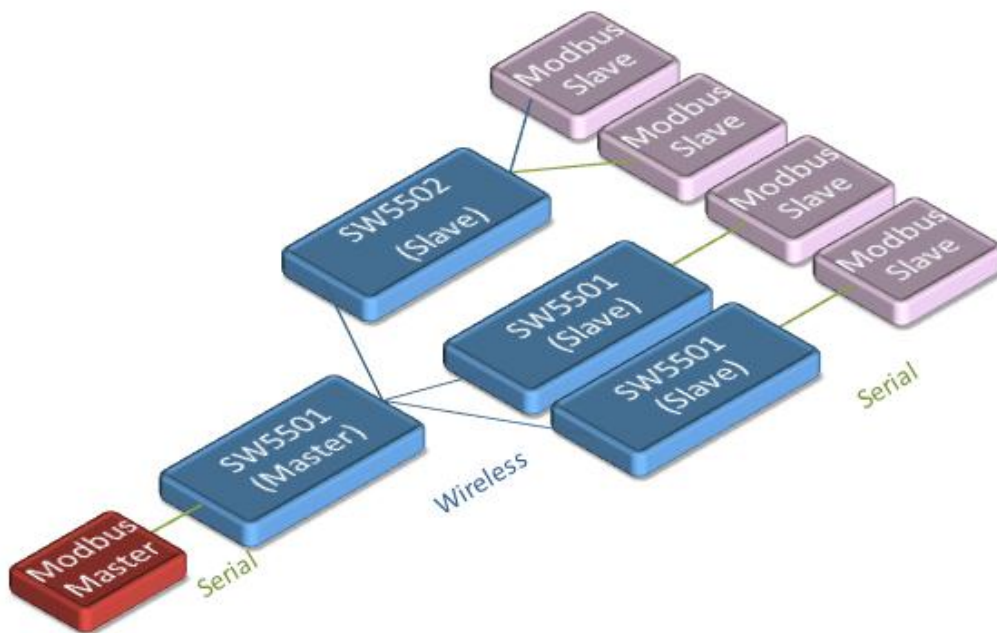

Fig. 4. 18

4.3 Wireless Topology

4.3.1 Configure SW550X as a Wireless Ad-Hoc Peer

System Status > Overview		SW5502
Basic Settings		
Radio Off	<input type="checkbox"/> Enabled	
SSID	Adhoc_Peer <input type="button" value="scan network"/>	
BSSID(MAC Address)	(Any) <input type="checkbox"/> Enabled	
WPS BUTTON	<input type="button" value="Start WPS PBC"/>	
Topology	Ad-Hoc ▾	
Band mode	802.11b ▾	
TxRate	Best (auto) ▾	
Channel	1 ▾	
BandWidth	40MHz ▾	
Secondary Channel	5 ▾	
Authentication Mode	OPEN ▾	
Encryption Type	NONE ▾	
WEP Key		
<input checked="" type="radio"/> Key 1:	HEX (10 or 26 digits) ▾	0123456789
<input type="radio"/> Key 2:	HEX (10 or 26 digits) ▾	0123456788
<input type="radio"/> Key 3:	HEX (10 or 26 digits) ▾	0123456787
<input type="radio"/> Key 4:	HEX (10 or 26 digits) ▾	0123456786
WPA-PSK/WPA2-PSK		
Passphrase	<input type="password"/> <input checked="" type="checkbox"/> Hide	
WPA2(with Radius)		
User	SWXXXX	
Password	<input type="password"/>	
Certificates	<input type="text"/> <input type="button" value="Browse..."/>	
	<input type="button" value="Upload CA certifaicate"/> <input type="button" value="Upload Client certificate"/>	
	<input type="button" value="Show Certificates Information"/>	
Private key password	<input type="password"/>	
<input type="button" value="Save & Apply"/> <input type="button" value="Temporary Apply"/> <input type="button" value="Cancel"/>		

Fig. 4. 19

Configure your device as explained below.

Table 4. 3

Topology	Adhoc
Band Mode	802.11b (alternatively you could use 802.11a which is less affected by interference), it provides better wireless sensitivity with lower maximum rate at 11Mbps.
Tx Rate	Auto
Channel	1; we recommend using 1, 6, or 11 (for 2.4 GHz).
Authentication	Open
Encryption	WEP
WEP Key	For 64-bit encryption, enter 5 ASCII value or 13 Hexadecimal digits. For 128-bit encryption, enter 13 ASCII value or 26 Hexadecimal digits. Use 128-bit when possible.

4.3.2 Configure SW550X as a Wireless Client in the Infrastructure mode (PSK)

System Status > Overview
SW5502

Basic Settings

Radio Off	<input type="checkbox"/> Enabled
SSID	A W5500 scan network
BSSID(MAC Address)	(Any) <input type="checkbox"/> Enabled
WPS BUTTON	Start WPS PBC
Topology	Infrastructure ▾
Band mode	Auto ▾
TxRate	Best (auto) ▾
Channel	1 ▾
BandWidth	40MHz ▾
Secondary Channel	5 ▾
Authentication Mode	WPA2-PSK ▾
Encryption Type	AES ▾
WEP Key	
<input checked="" type="radio"/> Key 1:	HEX (10 or 26 digits) ▾ 0123456789
<input type="radio"/> Key 2:	HEX (10 or 26 digits) ▾ 0123456788
<input type="radio"/> Key 3:	HEX (10 or 26 digits) ▾ 0123456787
<input type="radio"/> Key 4:	HEX (10 or 26 digits) ▾ 0123456786
WPA-PSK/WPA2-PSK	
Passphrase	●●●●●●●●●● <input checked="" type="checkbox"/> Hide
WPA2(with Radius)	
User	SWXXXX
Password	●●●●●●●●
Certificates	<input type="text"/> Browse...
	Upload CA certifaicate Upload Client certificate
	Show Certificates Information
Private key password	●●●●●●●●

Save & Apply
Temporary Apply
Cancel

Fig. 4. 20

Configure your device as explained below.

Table 4. 4

Topology	Infrastructure
Band Mode	Auto
Tx Rate	Auto
Channel	Disabled (auto sensing)
Authentication	As defined by the Access Point
Encryption	As defined by the Access Point
WPA2-PSK passphrase	8~63 characters



Attention

We recommend using WPA2-PSK authentication with AES encryption as it is the most secure password-type security option without utilizing 802.1x.

4.3.3 Click -2-Go

It is possible to pair up two SW550X in Ad-Hoc mode or have it connect to AW5500 (Infrastructure) automatically without entering the Web UI. Refer to Serial Manager's manual for more details on this.

4.3.4 Configure SW550X as a Wireless Client in the Infrastructure mode (PEAP-MSCHAPv2)

System Status > Overview
SW5502

Basic Settings

Radio Off	<input type="checkbox"/> Enabled
SSID	A W5500 scan network
BSSID(MAC Address)	(Any) <input type="checkbox"/> Enabled
WPS BUTTON	Start WPS PBC
Topology	Infrastructure ▾
Band mode	Auto ▾
TxRate	Best (auto) ▾
Channel	1 ▾
BandWidth	40MHz ▾
Secondary Channel	5 ▾
Authentication Mode	WPA2(PEAP) ▾
Encryption Type	AES ▾
WEP Key	
<input checked="" type="radio"/> Key 1:	HEX (10 or 26 digits) ▾ <input style="width: 100px;" type="text" value="0123456789"/>
<input type="radio"/> Key 2:	HEX (10 or 26 digits) ▾ <input style="width: 100px;" type="text" value="0123456788"/>
<input type="radio"/> Key 3:	HEX (10 or 26 digits) ▾ <input style="width: 100px;" type="text" value="0123456787"/>
<input type="radio"/> Key 4:	HEX (10 or 26 digits) ▾ <input style="width: 100px;" type="text" value="0123456786"/>
WPA-PSK/WPA2-PSK	
Passphrase	<input style="width: 100px;" type="password" value="●●●●●●●●"/> <input checked="" type="checkbox"/> Hide
WPA2(with Radius)	
User	<input style="width: 100px;" type="text" value="testuser"/>
Password	<input style="width: 100px;" type="password" value="●●●●●●●●"/>
Certificates	<input style="width: 100px;" type="text"/> Browse...
	Upload CA certifaicate Upload Client certificate
	Show Certificates Information
Private key password	<input style="width: 100px;" type="password" value="●●●●●●●●"/>

Save & Apply
Temporary Apply
Cancel

Fig. 4. 21

Configure your device as explained below.

Table 4. 5

Topology	Infrastructure
Band Mode	Auto
Tx Rate	Auto
Channel	Disabled (auto sensing)
Authentication	WPA2 (PEAP)
Encryption	As defined by the Access Point
Username	Defined by the RADIUS Server
Password	Defined by the RADIUS Server

5 VCOM Installation & Troubleshooting

5.1 Enabling VCOM

SW550X will encapsulate control packets on top of the real data when Virtual COM is enabled. This will allow the Virtual COM port in the Windows/Linux system to access SW550X's COM ports. Remember that VCOM can only be enabled on TCP Server Mode (Fig. 5. 2) or TCP Client (Fig. 5. 1).

LINK Mode

To choose specific working mode for COM 2 port.

TCP Server TCP Client UDP

<i>TCP Server</i>	
Application	RAW
IP Filter	<input type="checkbox"/> Enable
Source IP	0 . 0 . 0 . 0
Local Port	4660
Maximum Connection	1
Response Behavior	<input type="radio"/> Request & Response Mode <input type="radio"/> Reply to requester only <input checked="" type="radio"/> Reply to all <input checked="" type="radio"/> Transparent Mode

Fig. 5. 2

LINK Mode

To choose specific working mode for COM 2 port.

TCP Server TCP Client UDP

<i>TCP Client</i>	
Application	RAW
Destination IP 1	RAW
Destination Port 1	Virtual COM
Destination 2	<input type="checkbox"/> Enable
Destination IP 2	0 . 0 . 0 . 0
Destination Port 2	4661
Response Behavior	<input type="radio"/> Request & Response Mode <input type="radio"/> Reply to requester only <input checked="" type="radio"/> Reply to all <input checked="" type="radio"/> Transparent Mode

Fig. 5. 3

Virtual COM allows remote access of serial devices over TCP/IP networks through Serial/IP Virtual COM ports that work like local native COM ports. Fig. 5. 4 is a Virtual COM connection diagram.

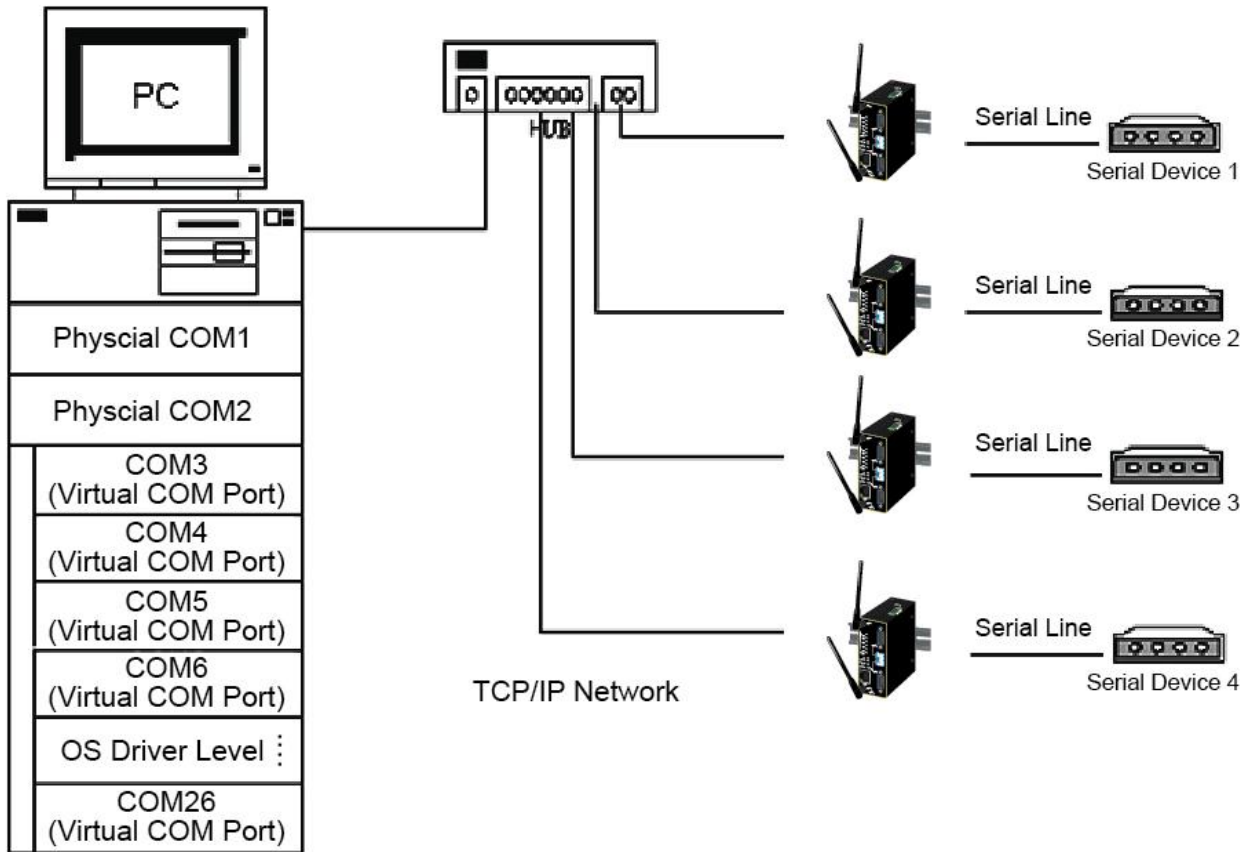

Fig. 5. 4

5.1.1 VCOM driver setup

System Requirements

- Windows Platform (32/64 bits)
 - Win7
 - 2008
 - Vista
 - XP
 - 2003 (also Microsoft 2003 Terminal Server)
 - 2000 (also Microsoft 2000 Terminal Server)
 - NT (also Microsoft NT Terminal Server)
 - 4.0
 - 9x
- Citrix MetaFrame Access Suite
- **Linux**, also available but first you might need to download a separate package called Virtual COM driver for Linux (**TTYredirector**) available for download on [Atop website](#) or in the product CD. The zipped package includes a binary file for installation and a manual for Linux systems.

5.1.2 Limitation

The Virtual COM driver allows up to 256 **Virtual COM ports** in a single PC. Selecting in the range from COM1 to COM4096 is allowed. Note that COM ports already occupied by the system or other devices will not be available.

5.1.3 Installation

Run the Virtual COM setup file included in the CD or download a copy from our website to install the Virtual COM driver for the operating system. Turn off your anti-virus software and try again if installation fails. At the end of the installation, please select at least one Virtual COM port from the Serial/IP Control Panel.

5.1.4 Uninstalling

- 1 From Windows Start Menu select Control Panel, Add/Remove Programs.
- 2 Select **Serial/IP Version x.x.x** in the list of installed software.
- 3 Click the **Remove** button to remove the program.

5.2 Enable VCOM Serial device servers and select VCOM in Windows

5.2.1 Enable VCOM in Serial device servers

Enable Virtual COM in our serial device servers by logging into our WebUI. It is located under **COM configuration**. The following figures show how to enable Virtual COM in SW550X. For a detailed **Link Mode configuration** with **Virtual COM**, please refer to the previous chapter starting from [Sec. 4.1](#) on **Link Mode configurations**.

LINK Mode

To choose specific working mode for COM 2 port.

TCP Server TCP Client UDP

TCP Server	
Application	Virtual COM ▾
IP Filter	<input type="checkbox"/> Enable
Source IP	0 . 0 . 0 . 0
Local Port	4660
Maximum Connection	1 ▾
Response Behavior	<input type="radio"/> Request & Response Mode <input type="radio"/> Reply to requester only <input checked="" type="radio"/> Reply to all <input checked="" type="radio"/> Transparent Mode

Fig. 5. 5

5.2.2 Running Serial/IP in Windows

Find Serial/IP Control Panel from:

- Start → All Programs → Serial/IP → Control Panel
- In the Windows Control Panel, open the Serial/IP applet.
- In the Windows notification area, Fig. 5. 6; right click in the Serial/IP tray icon and click on **Configure** to open the Control Panel.

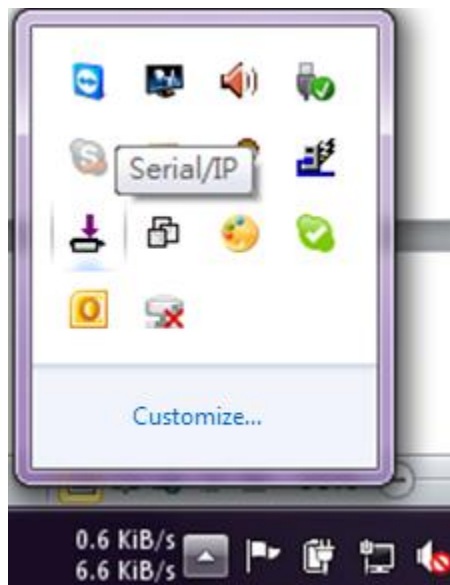

Fig. 5. 6

If no Virtual COM port is selected, a dialog will pop up and asks to select at least one port as the Virtual COM port before proceeding, Fig. 5. 7.

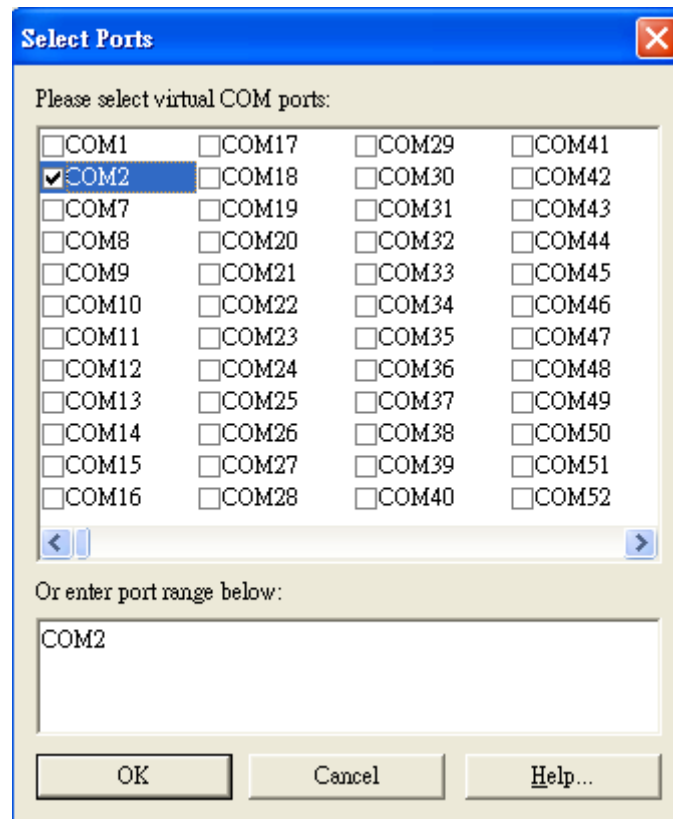

Fig. 5. 7

After at least one Virtual COM port is selected, the Control Panel will show, Fig. 5. 8.

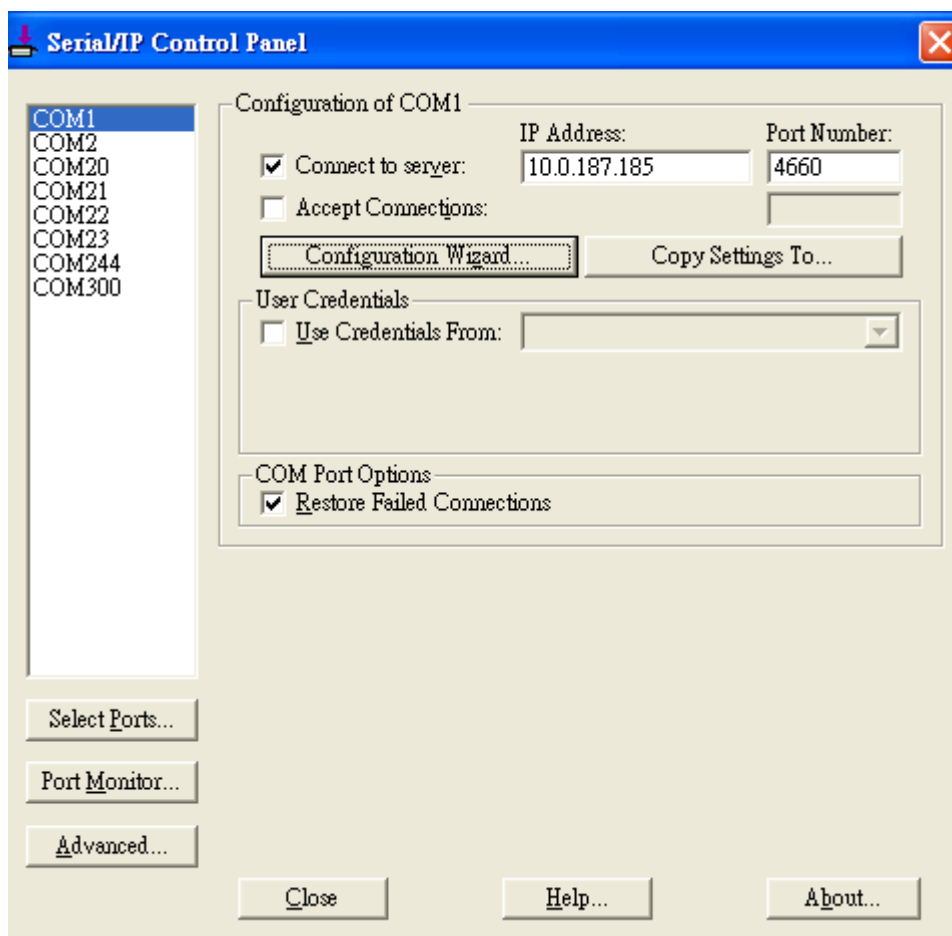

Fig. 5. 8

The left hand side of the Control Panel shows the list of selected Virtual COM ports. Click on **Select Ports** to add or remove Virtual COM ports from the list. The right hand side of the Control Panel shows the configurations of the selected Virtual COM port marked in blue. Each Virtual COM port can have its own settings.

Note: The changes to Virtual COM ports apply immediately, so there is no need to save the settings manually. However, if the Virtual COM port is already in use, it is necessary to close the Virtual COM port and open it after the TCP connection closes completely in order for the changes to take effect.

5.2.3 Configuring VCOM Ports

1. If the serial device server is running in TCP Server mode (recommended), a Serial/IP should be the TCP Client connecting to the serial device server. Enable **Connect to Server** and enter the **IP Address** of the serial device server with the **Port Number** specified. The **Port Number** here is the Local Listening Port for the serial device server.
2. If the serial device server is running in TCP Client mode, Serial/IP should be the TCP Server waiting for a serial device server to connect it. Enable **Accept Connections** and enter the **Port Number**. The **Port Number** here is the Destination Port of the serial device server. Do not enable **Connect to Server** and **Accept Connections** together.

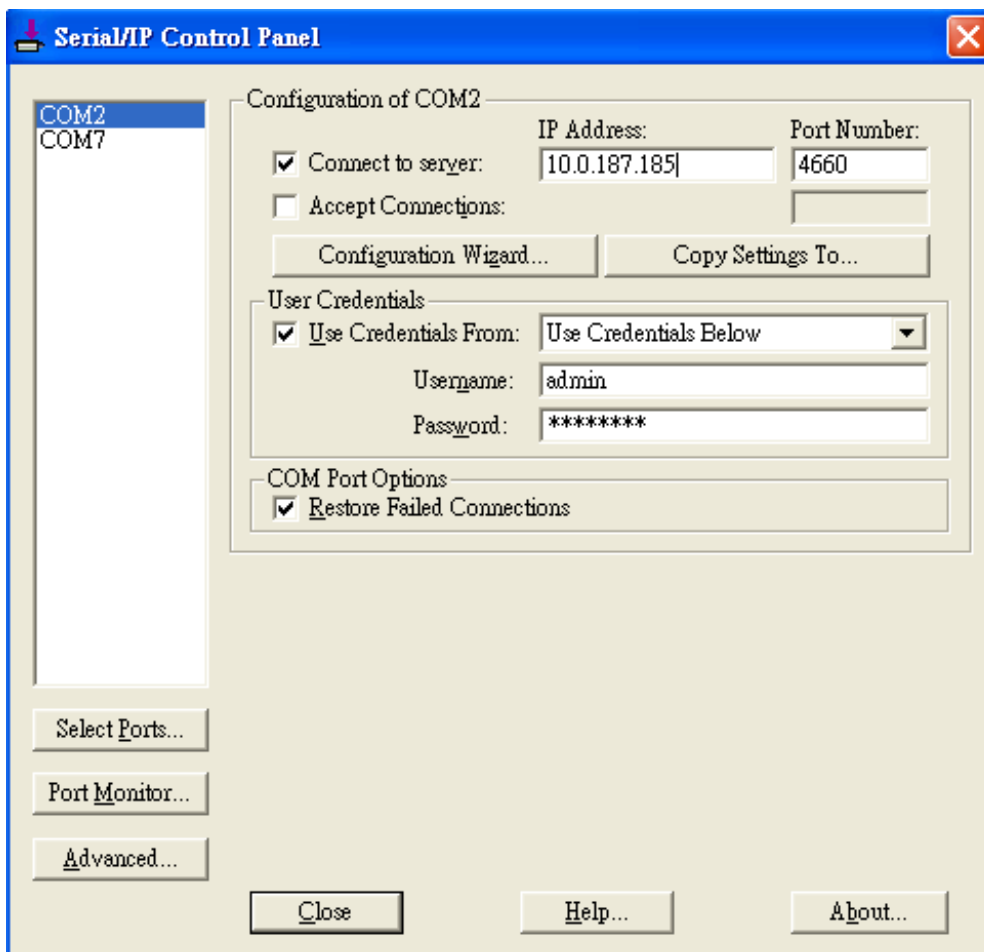

Fig. 5. 9

3. Enable **Restore Failed Connections** to force Virtual COM to automatically restore failed connections with the serial device server in the case of unstable network connections.
4. To test the Virtual COM connection, click the Configuration Wizard button and then click **Start** button in the pop up window (Fig. 5. 10). If the test passes, all checks should be in green. To apply the changes in the Configuration Wizard window to the Control Panel, click on **Use Settings**. Click on **Copy** to copy the results to the system clipboard.
5. To transfer the settings between Virtual COM ports, click on the **Copy Settings To** button.

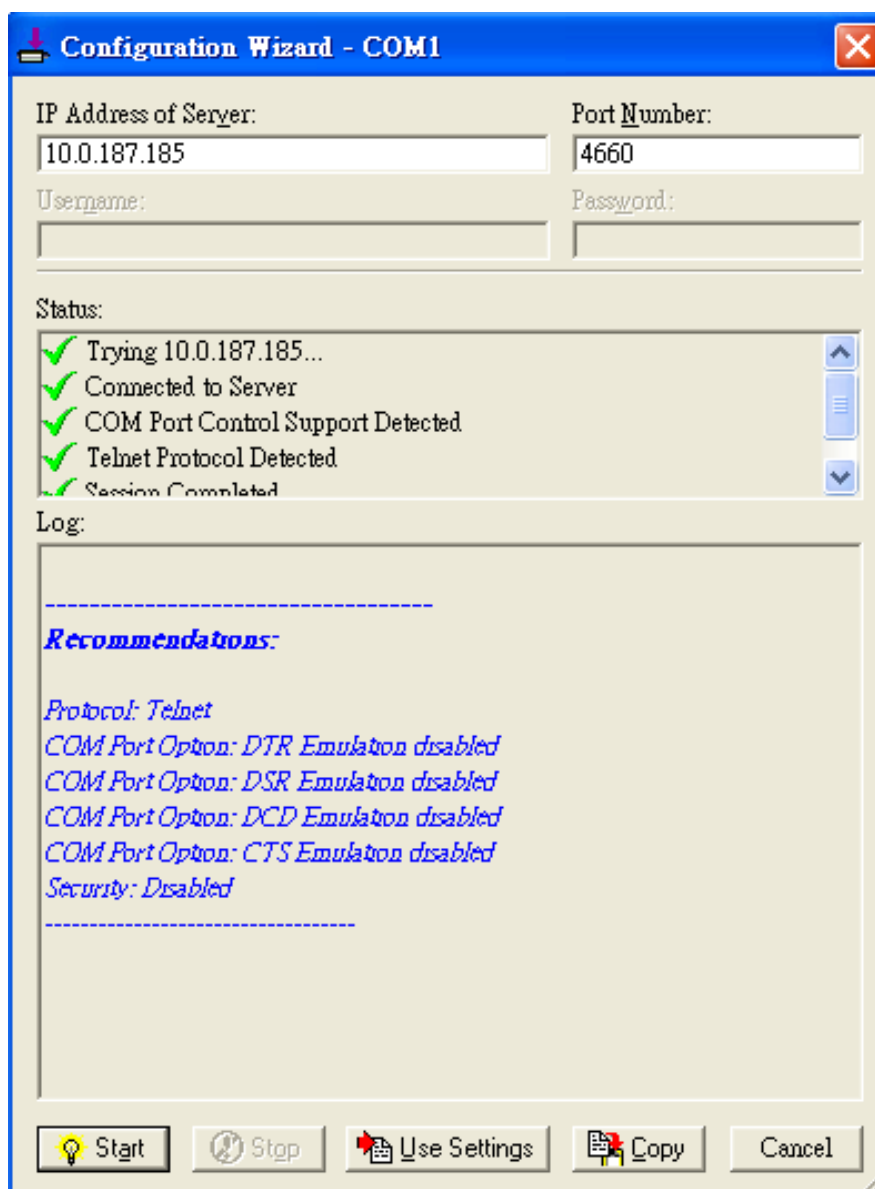

Fig. 5. 10

5.3 Exceptions

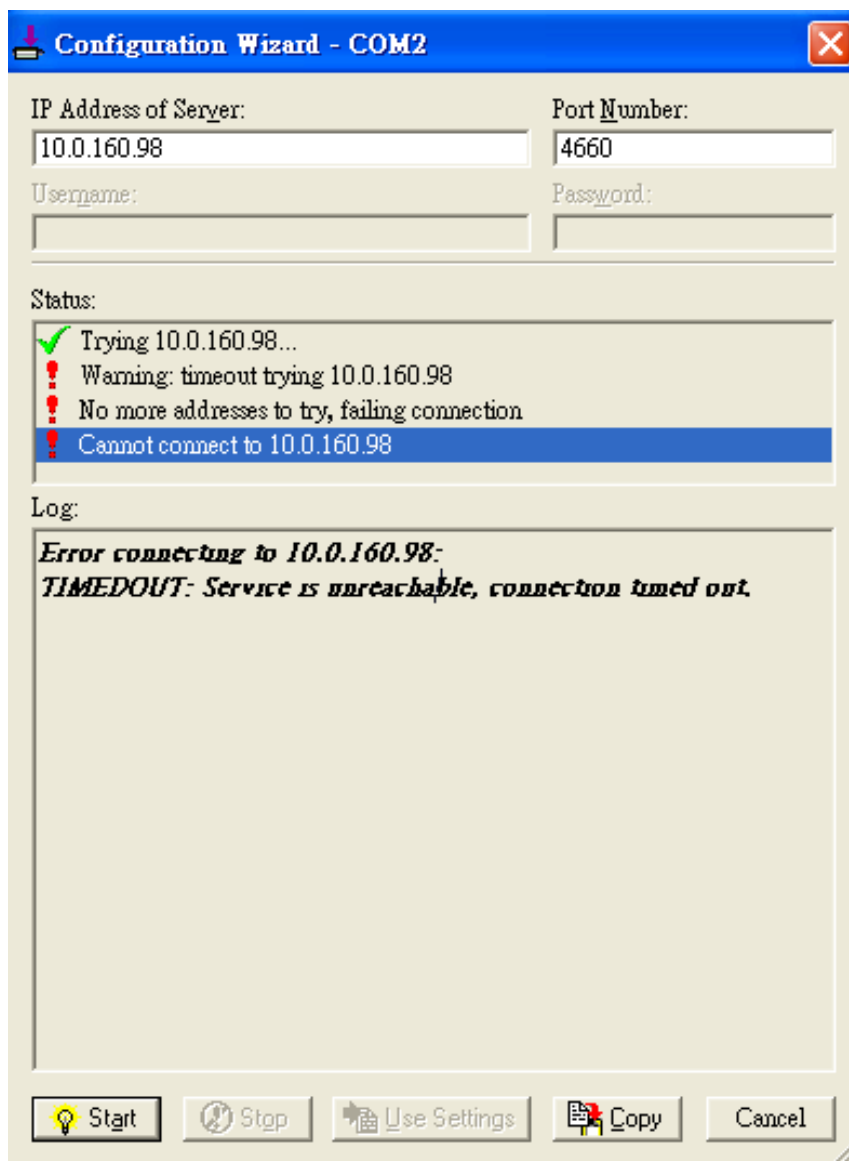

Fig. 5. 11

If the exclamation mark begins with **Warning: timeout trying x.x.x.x** as in Fig. 5. 11, recheck the **VCOM IP** and **Port configuration** or the PC's **network configuration**.

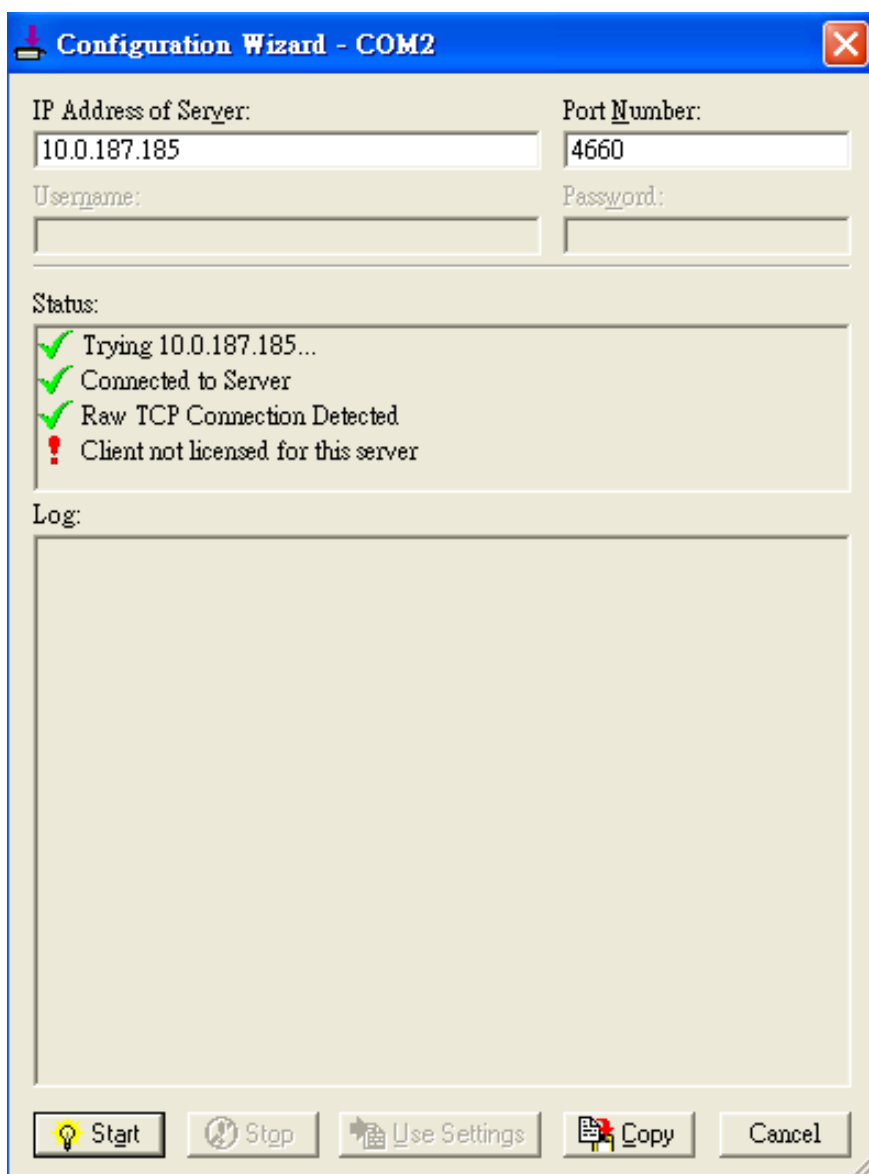

Fig. 5. 12

If there is a check with **Raw Connection Detected** and an exclamation mark with **Client not licensed for this server**, Fig. 5. 12, enable **VCOM** in the serial device server.

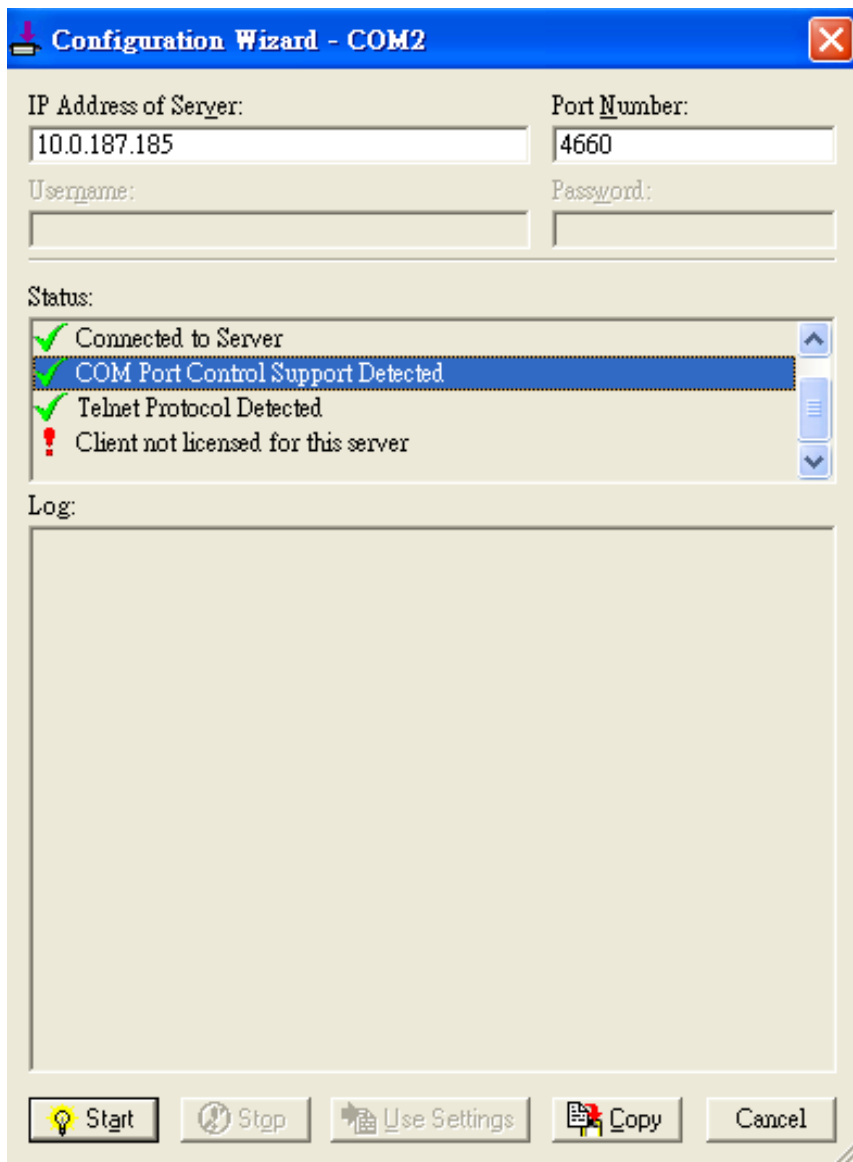

Fig. 5. 13

If there is a check with **Telnet Protocol Detected** and an exclamation mark with **Client not licensed for this server** as in Fig. 5. 13, this means that there is a licensing issue between the serial device server and Serial/IP. Please contact Atop technical support to obtain the correct VCOM software.

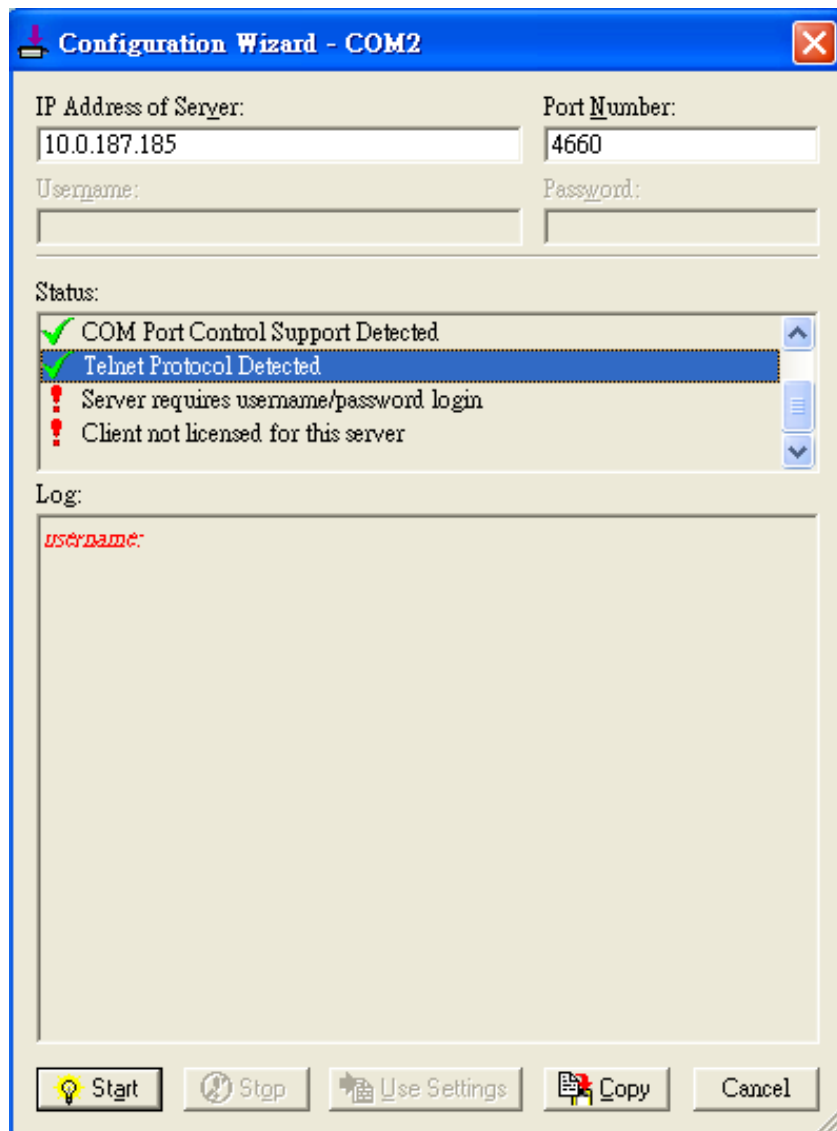

Fig. 5. 14

If the exclamation mark begins with **Server requires username/password login** Fig. 5. 14, it means **VCOM Authentication** in the serial device server is enabled, but credentials in the **Serial/IP** is not enabled.

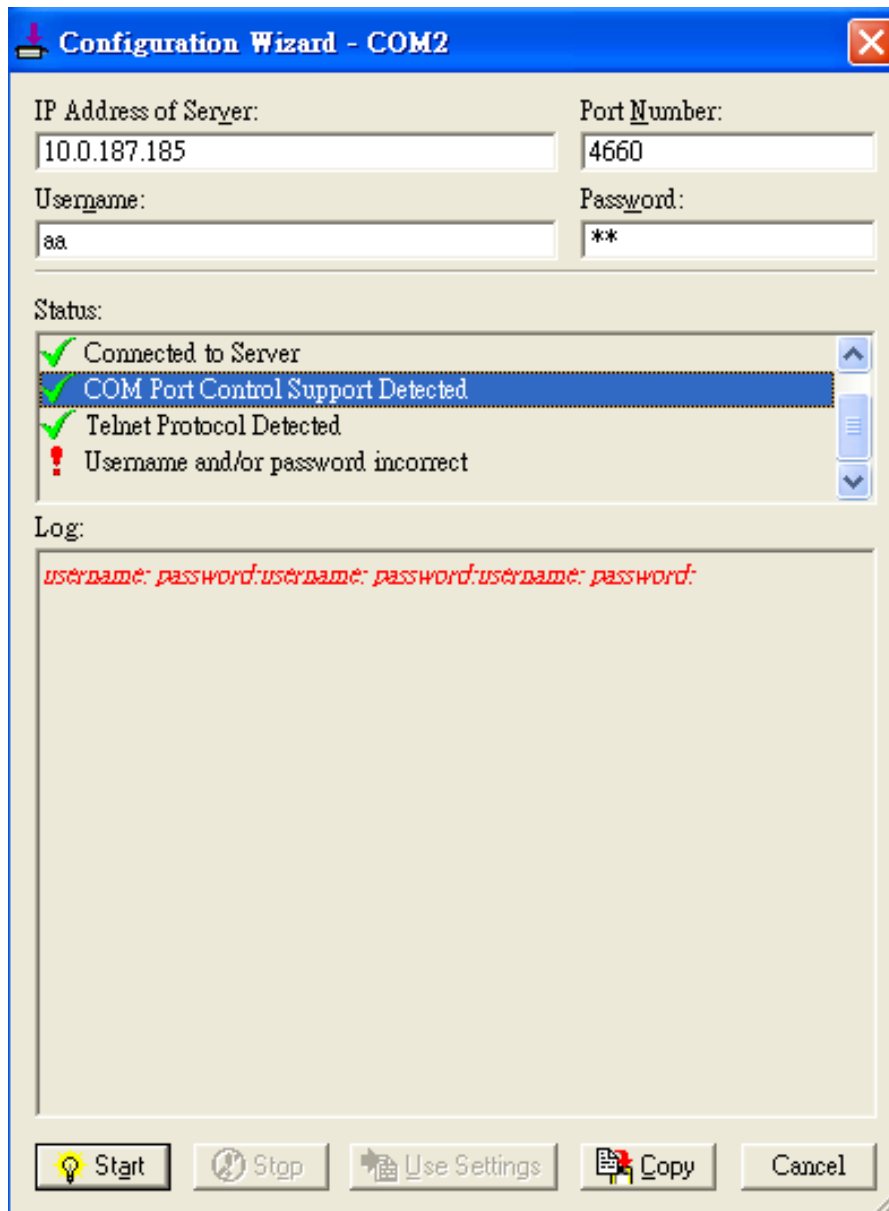

Fig. 5. 15

If the exclamation mark begins with a **“Username and/or password incorrect”**, Fig. 5. 15, this means the wrong username and/or password were entered and the authentication process failed.

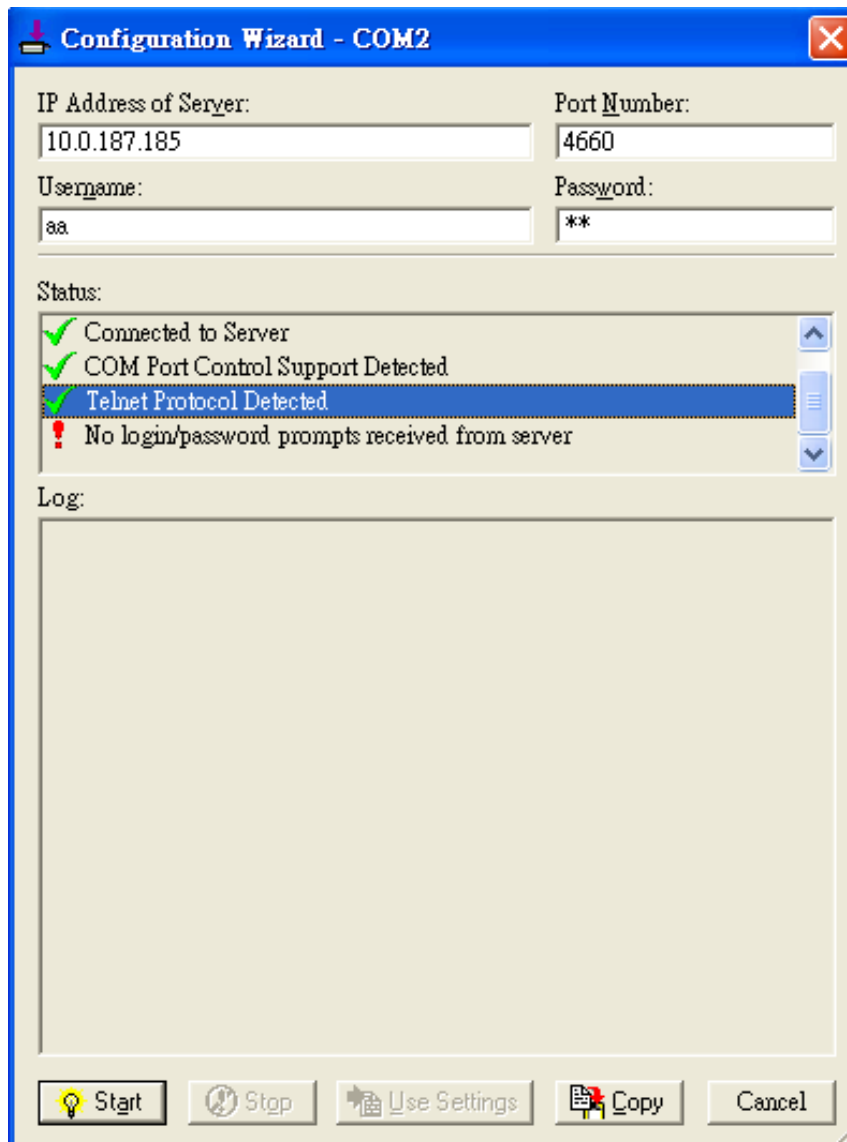

Fig. 5. 16

If the exclamation mark begins with **No login/password prompts received from server** Fig. 5. 16, it means credentials in the **Serial/IP** is enabled, but **VCOM Authentication** in the serial device server is not enabled.

5.4 Using Serial/IP Port Monitor

5.4.1 Opening the Port Monitor

The Serial/IP Port Monitor can be opened by:

- Start → All Programs → Serial/IP → Port Monitor
- Double click the Serial/IP tray icon in the Windows notification area.
- In the Windows notification area, right click in the Serial/IP tray icon and click on **Port Monitor** to open the Port Monitor.
- Click on the **Port Monitor** button in the Serial/IP Control Panel

5.4.2 The Activity Panel

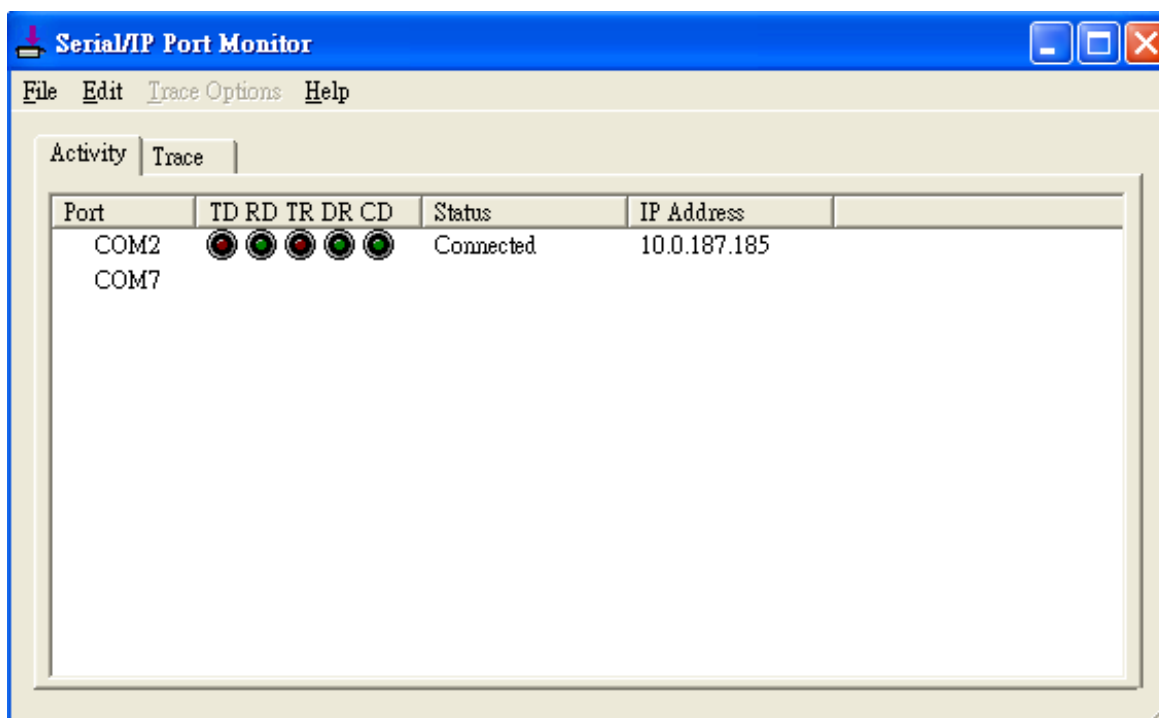

Fig. 5. 17

The Activity panel provides a real-time display of the status of all Serial/IP COM ports, Fig. 5. 17. If the Virtual COM Port is open and is properly configured to connect to a serial device server, the status would be **Connected**. If Serial/IP cannot find the specified serial device server, the status would be **Offline**.

5.4.3 The Trace Panel

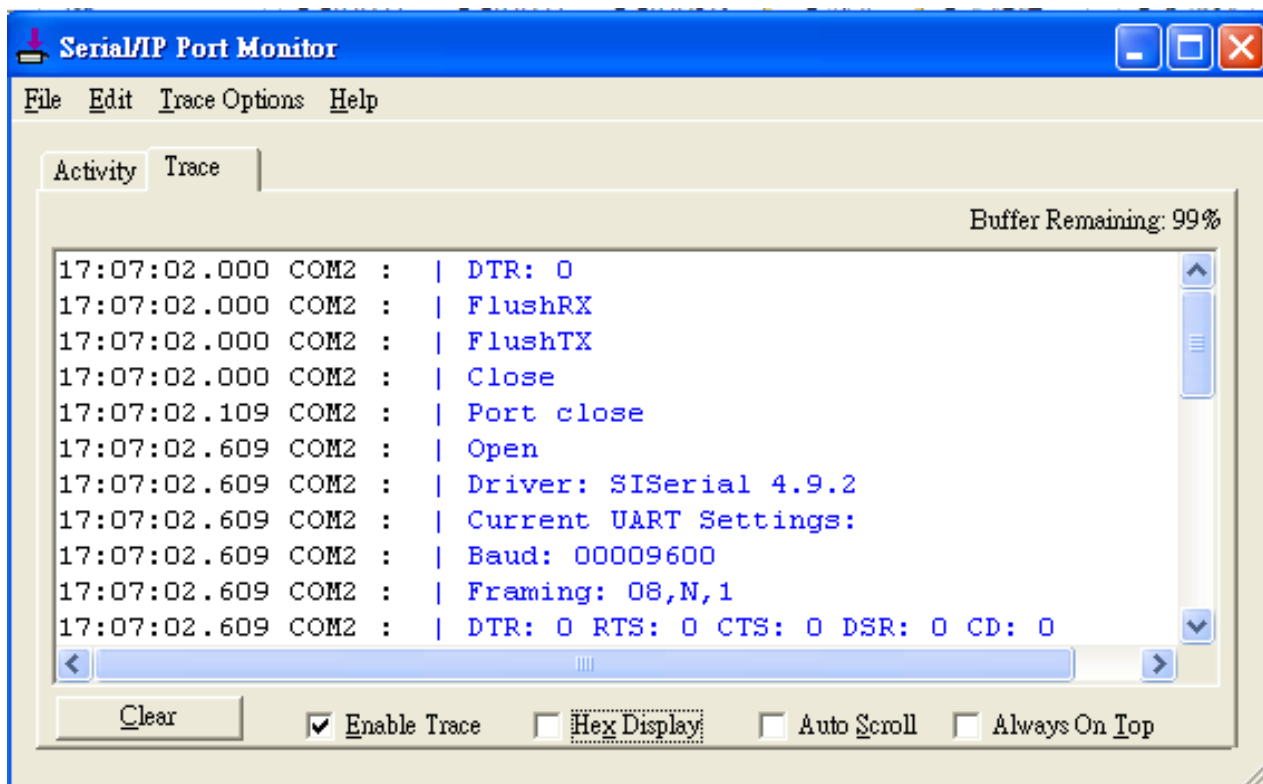

Fig. 5. 18

The Trace panel provides a detailed, time-stamped, real-time display of all Serial/IP COM ports operations, Fig. 5. 18. Click on **Enable Trace** to start logging Virtual COM communication. Click on File → Save As and send the log to Atop for analysis if problems arise with Virtual COM.

5.5 Serial/IP Advanced Settings

In the Serial/IP Control Panel, Click on the **Advanced** button to open Advanced Settings window (Fig. 5. 19). Click on **Use Default Settings** to load the default settings.

- **Extend Server Connection** Maintains the TCP connection for specified amount of time after COM port is closed
- **Attempt Server Connection** Terminates pending connection attempts if they do not succeed in the specified time
- **Synchronize with Server Upon COM Port Open** Required by NT Systems (2000, XP, Vista, 7)
- **Update Routing Table Upon COM Port Open** Maintains IP route to a server in a different subnet by modifying the IP routing table
- **Enable Nagle Algorithm** Provides better network efficiency by imposing a minor latency on the data stream while it waits to fill network packets
- **Always Limit Data Rate to COM Port Baud Rate** Limits the data rate to the baud rate that is in effect for the virtual COM port
- **Attempt Server Connection** If credential is set to Windows Credentials, VCOM automatically adds the current Windows domain to the username
- **COM Port Control Keep-Alive** Controls the interval at which VCOM will issue the keep-alive message, if no there is no activity
- **Maximum Connection Recovery Interval** Controls the maximum time for “Restore Failed Connection”
- **Enable SETXON/SETXOFF COM Port Commands** This option enables additional negotiation on SETXON and SETXOFF commands and is only available for the “V” series serial device servers. If the application requires SETXON/SETXOFF feature, please contact Atop Tech Support.

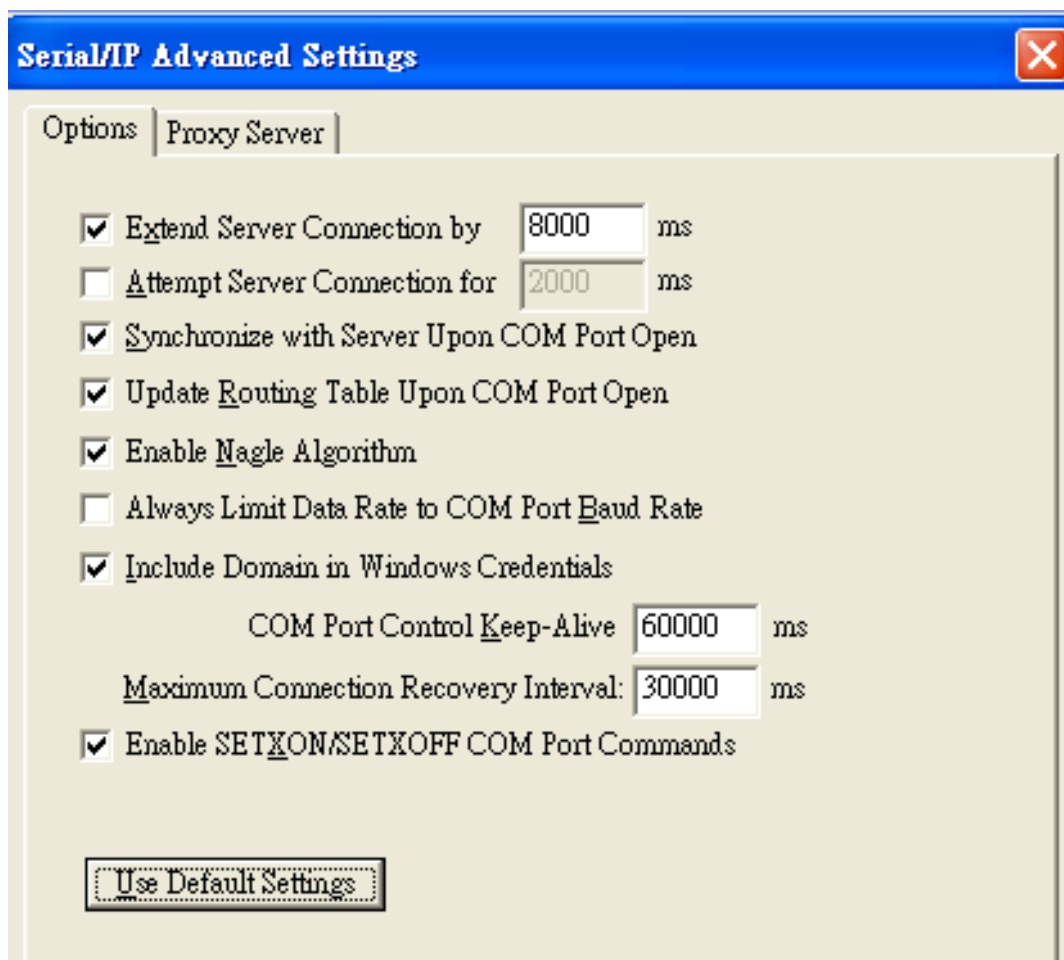

Fig. 5. 19

5.5.1 Using Serial/IP with a Proxy Server

The Serial/IP Redirector supports TCP network connections made through a proxy server, which may be controlling access to external networks (such as the Internet) from a private network that lacks transparent IP-based routing, such as NAT. Find Proxy Server settings from the Advanced Settings windows and switch to the **Proxy Server** tab, Fig. 5. 20.

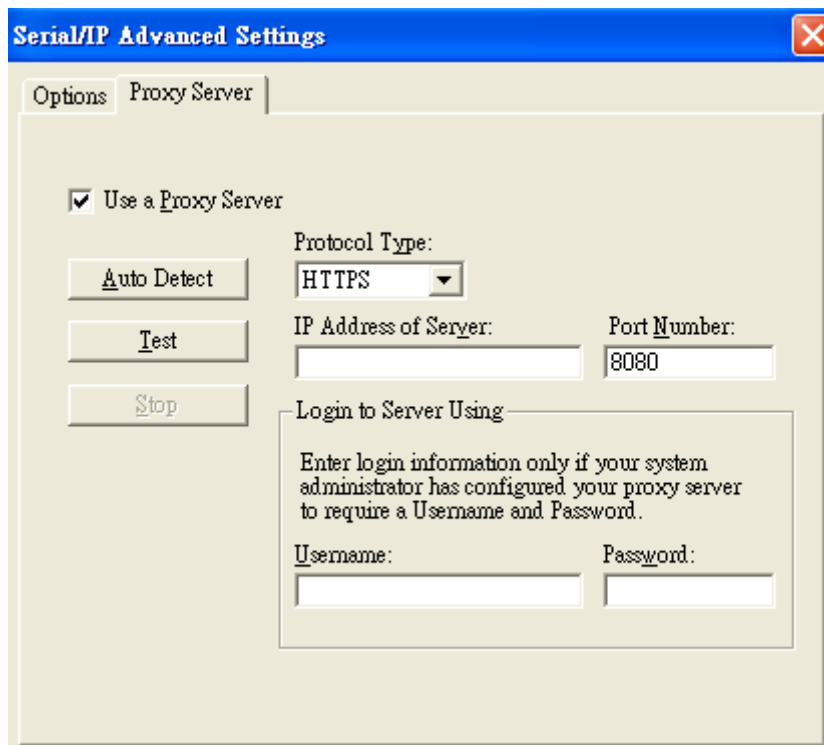

Fig. 5. 20

6 Specifications

6.1 Hardware

Models

Table 6. 1

Name	Serial Port			Ethernet
	DB9	TB5	TB5(ISO)	RJ45
SW5501	1	--	--	1
SW5501-TB	--	1	--	1
SW5501-Sis	--	--	1	1
SW5502	1	--	--	1
SW5502-TB	--	1	--	1
SW5502-Sis	--	--	1	1

Physical Characteristics

Table 6. 2

Housing	Front-Panel	Weight	Dimensions	Installation
IP50 protection, metal case	Common ID design	500g (approx.)	47 mm x 110 mm x 90mm	<ul style="list-style-type: none"> ● DIN-Rail ● Wall mount (optional kit)

LED Indicators

Table 6. 3

Name	Color	Status	Description
COM	Green	Blinking	Data transmitting on the serial port
		Off	Data is not transmitting on the serial port
LAN	Orange	Blinking	Ethernet is Connected on 10Mbps
		On	Ethernet is Connected on 100/1000Mbps
		Off	Ethernet is Disconnected

	Green	Blinking	Data is transmitting on Ethernet
WLAN	Green	On	Wireless Radio is enabled
		Blinking	Wireless Radio is enabled and data is transmitting
		Off	Wireless Radio is disabled (Mode LEDs should also disable)
RUN	Green	Off	System is not powered on
		Blinking Steadily	AP firmware is running normally
		Blinking Rapidly	AP firmware is not running

Signal LEDs

○ Off ● On ☼ blinking

Table 6. 4

Operations		Status	LED1	LED2	LED3	LED4	LED5
Connecting	Searching for an AP	☼	☼	☼	☼	☼	☼
	Cannot connected to the AP	☼					
	No IP provided by the DHCP Server	☼	☼				
Connected	Signal Strength is less 20%	●					
	Bad Signal Strength (20%-40%)	●	●				
	Poor Signal Strength (40%-60%)	●	●	●			
	Fair Signal Strength (60%-80%)	●	●	●	●		
	Good Signal Strength (80%-94%)	●	●	●	●	●	
	Excellent Signal Strength (95%-100%)	●	●	●	●	●	●

Dip Switch (SW5501)

Table 6. 5

COM	Dip	Function	SW	Ω
COM1	3	Pull High	On	1K
			Off	100K
	2	Pull Low	On	1K
			Off	100K
	1	Termination	On	120
			Off	0

Dip Switch (SW5502)

Table 6. 6

COM	Dip	Function	SW	Ω
COM1	6	Pull High	On	1K
			Off	100K
	5	Pull Low	On	1K
			Off	100K
	4	Termination	On	120
			Off	0
COM2	3	Pull High	On	1K
			Off	100K
	2	Pull Low	On	1K
			Off	100K
	1	Termination	On	120
			Off	0

Wireless Specifications

Table 6. 7

PCI-e Module	Tx/Rx	Wireless Standard Conformance	Antenna
Atheros AR9382	2T2R MIMO (2x2 with MCS 0-15)	<ul style="list-style-type: none"> ■ 802.11a ■ 802.11b ■ 802.11g ■ 802.11n 	<ul style="list-style-type: none"> ■ 3/5 dBi Dual antenna design ■ SMA(R) Female connector

Frequency Range:

Table 6. 8

	2.4Ghz	5Ghz
United States (FCC)	■ 2412-2462(20Mhz)	■ 5180-5240, 5745-5825(20Mhz)
	■ 2422-2452(40Mhz)	■ 5190-5230, 5755-5795(40Mhz)
Europe (ETSI)	■ 2412-2472(20Mhz)	■ 5180-5240(20Mhz)
	■ 2422-2462(40Mhz)	■ 5190-5230(40Mhz)
Taiwan (NCC)	■ 2412-2462(20Mhz)	■ 5280-5320, 5745-5825(20Mhz)
	■ 2422-2452(40Mhz)	■ 5310, 5755-5795(40Mhz)

Data Rate:

Table 6. 9

802.11a	6, 9, 12, 18, 24, 36, 48, 54Mbps
802.11b	1, 2, 5.5 and 11Mbps
802.11g	6, 9, 12, 18, 24, 36, 48, 54Mbps
802.11n	20 MHz ■ 1Nss: 65Mbps @ 800GI, 72.2Mbps @ 400GI (Max.)
	■ 2Nss: 130Mbps @ 800GI, 144.4Mbps @ 400GI (Max.)
	40MHz ■ 1Nss: 135Mbps @ 800GI, 150Mbps @ 400GI (Max.)
	■ 2Nss: 270Mbps @ 800GI, 300Mbps @ 400GI (Max.)

Output Power

Table 6. 10

802.11a	<ul style="list-style-type: none"> ■ +15dBm @ 6, 9, 12, 18, 24Mbps ■ +15dBm @ 36Mbps ■ +12dBm @ 54Mbps 	<ul style="list-style-type: none"> ■ +14dBm @ 48Mbps ■ +12dBm @ 54Mbps
802.11b	<ul style="list-style-type: none"> ■ +14dBm 	
802.11g	<ul style="list-style-type: none"> ■ +17dBm @ 6, 9, 12, 18, 24Mbps ■ +17dBm @ 36Mbps 	<ul style="list-style-type: none"> ■ +16dBm @ 48Mbps ■ +16dBm @ 54Mbps
802.11n 2.4GHz/HT20	<ul style="list-style-type: none"> ■ +16dBm @ MCS 0/8 ■ +16dBm @ MCS 1/9 ■ +16dBm @ MCS 2/10 ■ +16dBm @ MCS 3/11 	<ul style="list-style-type: none"> ■ +16dBm @ MCS 4/12 ■ +16dBm @ MCS 5/13 ■ +16dBm @ MCS 6/14 ■ +15dBm @ MCS 7/15
802.11n 2.4GHz/HT40	<ul style="list-style-type: none"> ■ +15dBm @ MCS 0/8 ■ +15dBm @ MCS 1/9 ■ +15dBm @ MCS 2/10 ■ +15dBm @ MCS 3/11 	<ul style="list-style-type: none"> ■ +15dBm @ MCS 4/12 ■ +15dBm @ MCS 5/13 ■ +15dBm @ MCS 6/14 ■ +14dBm @ MCS 7/15
802.11n 5GHz/HT20	<ul style="list-style-type: none"> ■ +15dBm @ MCS 0/8 ■ +15dBm @ MCS 1/9 ■ +15dBm @ MCS 2/10 ■ +15dBm @ MCS 3/11 	<ul style="list-style-type: none"> ■ +15dBm @ MCS 4/12 ■ +11 - 14dBm @ MCS 5/13 ■ +9 - 12dBm @ MCS 6/14 ■ +7 - 10dBm @ MCS 7/15
802.11n 5GHz/HT40	<ul style="list-style-type: none"> ■ +14dBm @ MCS 0/8 ■ +14dBm @ MCS 1/9 ■ +14dBm @ MCS 2/10 ■ +14dBm @ MCS 3/11 	<ul style="list-style-type: none"> ■ +14dBm @ MCS 4/12 ■ +10 - 13dBm @ MCS 5/13 ■ +8 - 11dBm @ MCS 6/14 ■ +6 - 9dBm @ MCS 7/15

Receiver Sensitivity

Table 6. 11

	Data Rate	IEEE Spec(1 Rx dBm)	Typical/Maximum(2Rx dBm)
802.11a	6M	-82	-95/-85
	9M	-81	-94/-84
	12M	-79	-93/+82
	18M	-77	-90/-80
	24M	-74	-88/-77
	36M	-70	-84/-73
	48M	-66	-82/-69
	54M	-65	-81/-68
802.11b	1M	not specified	-98/-85
	5.5M	not specified	-98/-85
	11M	not specified	-94/-85
802.11g	6M	-82	-96/-85
	9M	-81	-96/-84
	12M	-79	-95/-82
	18M	-77	-93/-80
	24M	-74	-90/-77
	36M	-70	-87/-73
	48M	-66	-83/-69
	54M	-65	-82/-68
802.11a/n HT20	MCS0	-82	-94/-85
	MCS1	-79	-92/-82
	MCS2	-77	-90/-80
	MCS3	-74	-87/-77

	MCS4	-70	-84/-73
	MCS5	-66	-79/-69
	MCS6	-65	-78/-68
	MCS7	-64	-76/-67
802.11a/n HT40	MCS0	-79	-92/-82
	MCS1	-76	-90/-79
	MCS2	-74	-87/-77
	MCS3	-71	-84/-74
	MCS4	-67	-80/-70
	MCS5	-63	-76/-66
	MCS6	-62	-74/-65
	MCS7	-61	-72/-64
802.11b/g/n HT20	MCS0	-82	-95/-85
	MCS1	-79	-94/-82
	MCS2	-77	-92/-80
	MCS3	-74	-89/-77
	MCS4	-70	-86/-73
	MCS5	-66	-82/-69
	MCS6	-65	-80/-68
	MCS7	-64	-78/-67
802.11b/g/n HT40	MCS0	-79	-92/-82
	MCS1	-76	-92/-79
	MCS2	-74	-89/-77
	MCS3	-71	-86/-74
	MCS4	-67	-83/-70
	MCS5	-63	-77/-66

	MCS6	-62	-76/-65
	MCS7	-61	-75/-64

Security

- 64-bit and 128-bit WEP encryption
- 802.1x authentication
- AES and TKIP, WPA/WPA2

Regulatory Requirements:

Table 6. 12

EMS	<ul style="list-style-type: none"> ■ EN55022 ■ EN55024
EMC	<ul style="list-style-type: none"> ■ EN 301489-1/17 (Class A) ■ FCC 15 Subpart B (Class A) ■ CNS 13438
Radio	<ul style="list-style-type: none"> ■ FCC 15 Sub section C, ■ FCC 15 Sub section E ■ EN 301893 ■ EN 300328 ■ NCC LP00002

Table 6. 13

Test	Item	Value	Level	
IEC61000-4-2	ESD	■ Contact Discharge	±8KV	4
		■ Air Discharge	±15KV	4
IEC61000-4-3	RS	■ Radiated(Enclosure)	10(V/m)	3
IEC61000-4-4	EFT	■ AC Power Port	±2.0 KV	3
		■ LAN Port	±2.0 KV	4
		■ COM Port	±2.0 KV	4
IEC61000-4-5	Surge	■ AC Power Port	Line-to-Line±1.0 KV	3
		■ AC Power Port	Line-to-Earth±2.0 KV	3
		■ LAN Port	Line-to-Earth±2.0 KV	3
		■ COM Port	Line-to-Earth±2.0 KV	3
IEC61000-4-6	CS	■ Conducted(Enclosure)	10 V rms	3
IEC61000-4-8	PFMF	■ (Enclosure)	10(A/m)	3
IEC61000-4-11	DIP	AC Power Port	-	-

*AC Ports are tested through an authorized power adaptor.

Environmental Limits

- **Operating Temperature:** -10°C ~60°C (-4°F ~149°F)
- **Storage Temperature:** -40°C ~85°C (-40°F ~ 185°F)
- **Ambient Relative Humidity:** 5~95%RH, (non-condensing)

Other

- **Safety:** UL60950-1/CB, EN60950-1, CNS 14336
- **Shock:** IEC 60068-2-27
- **Freefall:** IEC 60068-2-32
- **Vibration:** IEC 60068-2-6
- **MTBF:** 20 years (TBD)
- **RoHS:** Yes
- **Maritime:** N/A

6.2 Software Specifications

Table 6. 14

Configuration	<ul style="list-style-type: none"> ■ Browser (IE8+, Firefox 6+, and Chrome 13+) ■ Telnet ■ Serial Manager© (Windows utility)
Protocol	<ul style="list-style-type: none"> <li style="width: 33%;">■ ICMP <li style="width: 33%;">■ DNS <li style="width: 33%;">■ HTTP <li style="width: 33%;">■ TCP <li style="width: 33%;">■ SNMP <li style="width: 33%;">■ Telnet <li style="width: 33%;">■ RADIUS <li style="width: 33%;">■ UDP <li style="width: 33%;">■ NTP <li style="width: 33%;">■ IPv4 <li style="width: 33%;">■ Syslog <li style="width: 33%;">■ DHCP <li style="width: 33%;">■ SMTP <li style="width: 33%;">■ 802.1x
Alert Events	<ul style="list-style-type: none"> ■ E-mail ■ SNMP Trap
Radio OFF option	Yes
Other	<ul style="list-style-type: none"> ■ Config Import / Export from Web with Wireless settings ■ Firmware upgrade through Web or Serial Manager© ■ Site Monitor / Site Survey ■ LAN / WLAN Bridge (AP Client) ■ Management List

Emergency System Recovery

If your device becomes inaccessible and the management utility cannot find your device, please use the following procedure to recover your device over TFTP.

System Recovery Procedures

System recovery is based on the TFTP Client embedded in the device. It can recover the device from a bad firmware or other unknown reasons that corrupted the firmware image inside the flash. Follow the procedures below to force SW550X to download a valid firmware from the TFTP Server to recover its Operating System.

Default Settings	
TFTP Server	10.0.50.201
TFTP Server Subnet Mask	255.255.0.0
Name of firmware Image*	firmware.dld
*This firmware image can be obtained from Atop's website.	

- If the device is beeping continuously after power up, the bootloader is damaged and there is no way to recover it; please contact directly Atop RMA for further solutions.
- Obtain and setup a **TFTP server** on your **PC**. Make sure that the **PC's network settings** are set properly according to the default above.
- Rename the firmware image that you obtained from our website to `firmware.dld` and place it in the TFTP Server's root directory. For Solarwinds TFTP Server, it is usually **C:\TFTP-Root**.
- Make sure that the device is powered OFF and the Ethernet cable is plugged in.
- Press and hold the reset to default pin next to the Antenna 2 then power ON the device. If the bootloader is still functioning, you will hear one long beep followed by two shorter beeps.
- Release the reset pin after you hear seven consecutive short beeps. You should see that the device requested files from your TFTP Server. Please wait until the device shows up on the management utility. This process could take five more minutes or more.

Important Note

You can download free TFTP Servers from the following locations:

Solarwinds TFTP Server http://www.solarwinds.com/products/freetools/free_tftp_server.aspx

Note: for Solarwinds, please remember to Start the TFTP Server Service, the default is Stop.

TFTPD32 TFTP Server <http://tftpd32.jounin.net/tftpd32.html>

Warranty

Limited Warranty Conditions

Products supplied by us are covered in this warranty for undesired performance or defects resulting from shipping, or any other event deemed to be the result of Atop Technologies' mishandling. The warranty does not cover however, equipment which has been damaged due to accident, misuse, abuse, such as:

- Use of incorrect power supply, connectors, or maintenance procedures
- Use of accessories not sanctioned by us
- Improper or insufficient ventilation
- Improper or unauthorized repair
- Replacement with unauthorized parts
- Failure to follow Our operating Instructions
- Fire, flood, "Act of God", or any other contingencies beyond our control.

RMA and Shipping Reimbursement

- Customers must always obtain an authorized "RMA" number from us before shipping the goods to be repaired.
- When in normal use, a sold product shall be replaced with a new one within 3 months upon purchase. The shipping cost from the customer to us will be reimbursed.
- After 3 months and still within the warranty period, it is up to us whether to replace the unit with a new one; normally, as long as a product is under warranty, all parts and labor are free of charge to the customers.
- After the warranty period, the customer shall cover the cost for parts and labor.
- Three months after purchase, the shipping cost from you to us will not be reimbursed, but the shipping costs from us to the customer will be paid by us.

Limited Liability

Atop Technologies Inc., shall not be held responsible for any consequential losses from using our products.

Warranty

Atop Technologies Inc., gives a 5 years max for Wireless Access Point products.